

# **DF115BG DF140BG**

## **OWNER'S MANUAL**

# IMPORTANT

## ▲ WARNING/ ▲ CAUTION/ NOTICE/ NOTE

Please read this manual and follow its instructions carefully. To emphasize special information, the symbol ▲ and the words **WARNING**, **CAUTION**, **NOTICE** and **NOTE** have special meanings. Pay special attention to the messages highlighted by these signal words.

### ▲ WARNING

Indicates a potential hazard that could result in death or serious injury.

### ▲ CAUTION

Indicates a potential hazard that could result in minor or moderate injury.

### NOTICE

Indicates a potential hazard that could result in damage to the motor or boat.

#### NOTE:

Indicates special information to make maintenance easier or instructions clearer.



This symbol appears in various locations on your Suzuki product to refer you to important information in the owner's manual.

## IMPORTANT NOTICE TO OWNERS

### ▲ WARNING

Failure to take the proper precautions may increase the risk of death or severe injury to you and your passengers.

- Prior to first-time use of your outboard motor, familiarize yourself thoroughly with the contents of this owner's manual. Be aware of all outboard motor features and all safety and maintenance requirements.
- Inspect the boat and motor before each trip. See the **INSPECTION BEFORE BOATING** section for important items.

- Become thoroughly familiar with all operating and handling characteristics of your boat and motor. Practice at low and moderate speeds until you are competent at handling the boat and motor. Do not attempt to operate at maximum performance until you are completely familiar with all of these characteristics.
- Carry boating safety and emergency equipment. This important equipment includes; flotation aids for each person (plus one throwable buoyant cushion in any boat 16 feet or longer), fire extinguisher, sound signaling device, visual distress signals, anchor, bilge pump, bucket, compass, emergency starter rope, extra fuel and oil, first aid kit, flashlight, food and water, mirror, paddles, tool kit, and transistor radio. Be sure you are carrying the equipment appropriate for your trip before launching.
- Never start the engine or let it run indoors or where there is little or no ventilation. Exhaust gas contains carbon monoxide, a gas that is colorless and odorless and can cause death or severe injury.
- Instruct your passengers on how to operate the boat, how to deal with emergencies, and how to operate safety and emergency equipment.
- Do not hold onto the motor cover or any other parts of your outboard motor while getting on or off your boat.
- Ensure that everyone wears a PFD (Personal Flotation Device) on board.
- Never operate the boat while under the influence of alcohol or other drugs.
- Distribute all weight load evenly in the boat.
- Have all scheduled maintenance performed. Consult your authorized Suzuki marine dealer as required.
- Do not modify or remove any outboard motor standard equipment. To do so may make the motor unsafe to use.
- Learn and obey all applicable navigation rules.
- Pay attention to all weather forecasts. Do not set out if weather is unsettled.
- Use extreme caution when purchasing replacement parts or accessories. Suzuki strongly recommends that you use only genuine Suzuki replacement parts/accessories or their equivalent. Inappropriate or poor quality replacement parts or accessories can create unsafe operating conditions.

- Never remove the flywheel cover (except for when emergency starting).

**NOTE:**

*Mounting radio transceiver or navigational equipment antennae too close to the engine cowling can cause electrical noise interference. Suzuki recommends that antennae be mounted at least one meter (40 inches) away from the engine cowling.*

**This manual should be considered a permanent part of the outboard motor and should remain with the outboard motor when resold or otherwise transferred to a new owner or operator. Please read this manual carefully before operating your new Suzuki and review the manual from time to time. It contains important information on safety, operation, and maintenance.**

## FOREWORD

Thank you for choosing a Suzuki outboard motor. Please read this manual carefully and review it from time to time. It contains important information on safety, operation, and maintenance. A thorough understanding of the information presented in this manual will help you experience safe, enjoyable boating.

All information in this manual is based on the latest product information available at the time of publication. Due to improvements or other changes, there may be discrepancies between this manual and your outboard motor. Suzuki reserves the right to make changes at any time without notice.

# TABLE OF CONTENTS

IDENTIFICATION NUMBER	
LOCATION.....	5
FUEL AND OIL.....	5
LOCATION OF SAFETY LABELS .....	8
LOCATION OF PARTS.....	9
MOTOR MOUNTING.....	11
BATTERY INSTALLATION .....	11
USE OF ELECTRICAL ACCESSORIES .....	13
SUZUKI KEYLESS START SYSTEM (IF EQUIPPED WITH KEYLESS START SYSTEM) .....	14
PROPELLER SELECTION AND INSTALLATION.....	18
ADJUSTMENT.....	19
METER (OPTION) MULTI-FUNCTION GAUGE .....	23
CAUTION SYSTEM.....	34
ELECTRONIC THROTTLE AND SHIFT CONTROL CAUTION SYSTEM.....	39
KEYLESS START SYSTEM CAUTION SYSTEM (IF EQUIPPED WITH KEYLESS START SYSTEM) .....	42
DIAGNOSTIC SYSTEM .....	44
OIL CHANGE REMINDER SYSTEM.....	44
ENGINE STALLING CAUTION SYSTEM.....	47
WATER IN FUEL ALERT SYSTEM.....	47
OPERATION OF TILTING SYSTEMS.....	47
INSPECTION BEFORE BOATING ...	50
BREAK-IN .....	51
OPERATION .....	52
MOTOR REMOVAL AND TRANSPORTING .....	69
TRAILERING.....	70
INSPECTION AND MAINTENANCE.....	71
FLUSHING THE WATER PASSAGES.....	83

SUBMERGED MOTOR.....	85
STORAGE PROCEDURE .....	86
AFTER STORAGE .....	87
TROUBLESHOOTING .....	87
SPECIFICATIONS .....	91
INFORMATION REGARDING EC – DIRECTIVE .....	91
FLOWCHART OF OIL CHANGE REMINDER SYSTEM.....	92

# IDENTIFICATION NUMBER LOCATION

The model and identification numbers of your outboard motor are stamped on a plate attached to the clamp bracket. It is important to know these numbers when you place a parts order or if your motor is stolen.

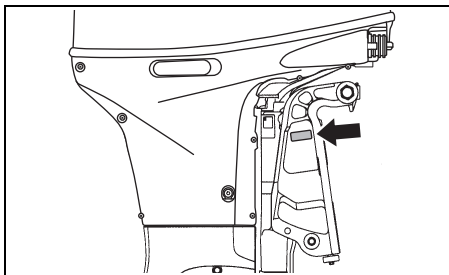

# FUEL AND OIL

## GASOLINE

Suzuki highly recommends that you use alcohol-free unleaded gasoline whenever possible, with a minimum octane rating of 91 (Research method). However, blends of unleaded gasoline and alcohol with equivalent octane content may be used, provided the guidelines that follow are met.

### NOTICE

**Use of leaded gasoline can cause engine damage. Use of improper or poor quality fuel can affect performance and may damage your motor and fuel system.**

**Use only unleaded gasoline. Do not use fuel having lower than the recommended octane, or fuel that may be stale or contaminated by dirt/water etc.**

### NOTE:

*Oxygenated fuels are fuels which contain oxygen-carrying additives such as alcohol.*

Suzuki recommends that you install a water-separating fuel filter assembly between your boat's fuel tank(s) and outboard motor(s). Fuel filtration systems of this type will help prevent water that may be present in your boat's fuel tank(s) from contaminating your motor's electronic fuel injection system. Water contamination can cause poor engine performance and can also cause damage to the electronic fuel injection system components.

Your Authorized Suzuki Marine Dealer can provide you advice about water-separating fuel filter systems and installation.

## Gasoline/Ethanol Blends

Blends of unleaded gasoline and ethanol (grain alcohol), also known as "GASOHOL", are commercially available in some areas. Blends of this type may be used in your outboard motor if they are no more than 10% ethanol. Make sure this gasoline-ethanol blend has octane ratings no lower than those recommended for gasoline.

Use the recommended gasoline which conforms to the following labels.

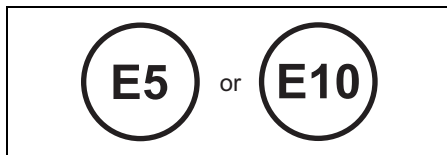

## Pump Labeling for Gasoline/Alcohol Blends

In some states, pumps that dispense gasoline/alcohol blends are required to be labeled for the type and percentage of alcohol content, and whether important additives are present. Such labels may provide enough information for you to determine if a particular blend of fuel meets the requirements listed above. In other states, pumps may not be clearly labeled as to the content or type of alcohol and additives. If you are not sure that the fuel you intend to use meets these requirements, check with the service station operator or the fuel suppliers.

**NOTE:**

*If you are not satisfied with the operation or fuel economy of your outboard motor when you are using gasoline/alcohol blends, you should switch back to unleaded gasoline containing no alcohol.*

*Be sure that any gasoline/alcohol blend you use has octane ratings of at least 91 octane (Research method).*

*If engine pinging is experienced, substitute another brand as there are differences between brands.*

*Unleaded gasoline will extend spark plug life.*

**▲ WARNING**

**Gasoline is extremely flammable and toxic. It can cause a fire and can be hazardous to people and pets.**

**Always take the following precautions when refueling:**

- **Never permit anyone other than an adult to refill the fuel tank.**
- **If you use a portable fuel tank, always stop the motor and remove the fuel tank from the boat to refill it.**
- **Do not fill the fuel tank all the way to the top or fuel may overflow when it expands due to heating by the sun.**
- **Be careful not to spill fuel. If you do, wipe it up immediately.**
- **Do not smoke, and keep away from open flames and sparks.**

**NOTICE**

**Gasoline kept in the fuel tank for long periods of time will produce varnish and gum, which can damage the engine.**

**Always use fresh gasoline.**

**NOTICE**

**Fuels containing alcohol can cause paint damage, which is not covered under the New Outboard Motor Limited Warranty.**

**Be careful not to spill fuel containing alcohol while refueling. If fuel is spilled, wipe it up immediately.**

**NOTE:**

*The fuel tank supplied with this motor is its dedicated fuel reservoir and should not be used as a fuel storage container.*

# ENGINE OIL

## NOTICE

Use of poor quality engine oil can adversely affect engine performance and life.

Suzuki recommends that you use Suzuki Marine 4-Cycle Engine Oil or its equivalent.

Oil quality is a major contributor to your engine's performance and life. Always select good quality engine oil.

Suzuki recommends the use of SAE 10W-40 or 10W-30 SUZUKI MARINE 4-CYCLE ENGINE OIL. If SUZUKI MARINE 4-CYCLE ENGINE OIL is not available, select a NMMA certified FC-W oil or good quality 4-cycle motor oil from the following chart according to the average temperatures in your area.

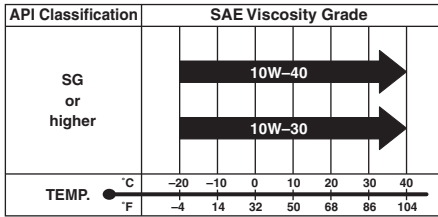

### NOTE:

In very cold weather (below 5°C (41°F)), use SAE (or NMMA FC-W) 5W-30 for easier starting and smooth operation.

## GEAR OIL

Suzuki recommends the use of SUZUKI OUTBOARD MOTOR GEAR OIL. If it is not available, use SAE 90 hypoid gear oil which is rated GL-5 under the API classification system.

# LOCATION OF SAFETY LABELS

Read and follow all of the labels on your outboard motor or fuel tank. Make sure you understand all of the labels.

Keep the labels on your outboard motor or fuel tank. Do not remove them for any reason.

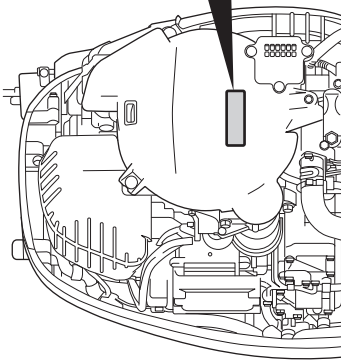
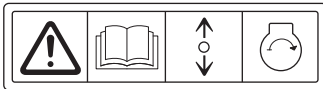
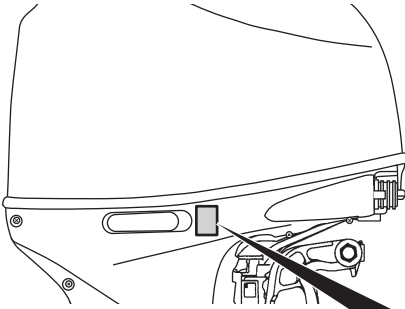

**▲ WARNING AVERTISSEMENT**

- Fuel can leak creating a fire hazard if you lay motor on its side. Drain fuel completely from vapor separator or carburetor before laying motor on its side.
- See owner's manual for details.

---

- Le carburant risque de fuir et de présenter un danger d'incendie si le moteur est placé sur le côté. Vidanger entièrement le carburant du séparateur de vapeurs ou du carburateur avant de procéder.
- Pour plus de détail, voir le manuel du propriétaire.

## Label symbol meanings

These symbols mean as follows;

- : General warning symbol (Caution or Warning)
- : Read owner's manual carefully
- : Remote control lever/gear shift lever operation-two direction; Forward/Neutral/Reverse

- : Engine start
- : Hazard caused by fire
- : Hazard caused by laying the motor on its side



# LOCATION OF PARTS

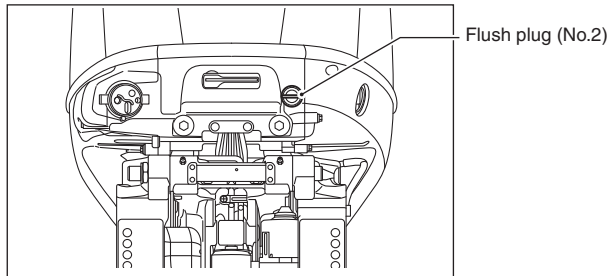
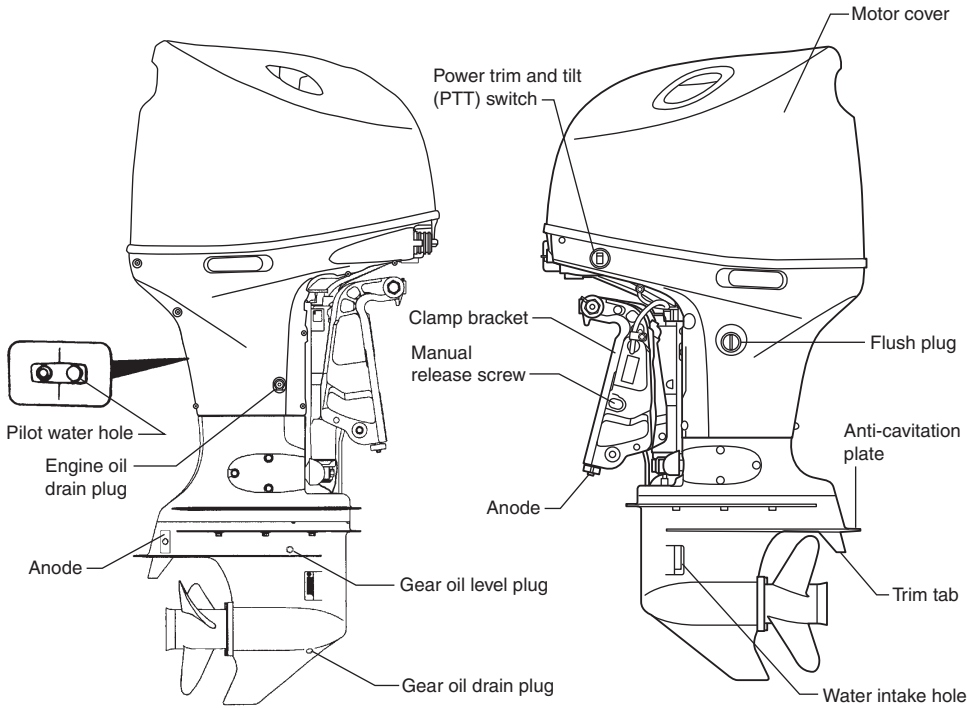

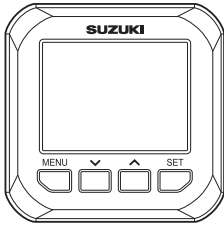

**MULTI-FUNCTION GAUGE**  
(Option)

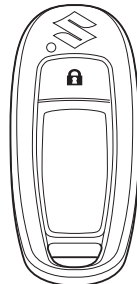

**KEYLESS FOB**  
(IF EQUIPPED WITH  
KEYLESS START SYSTEM)

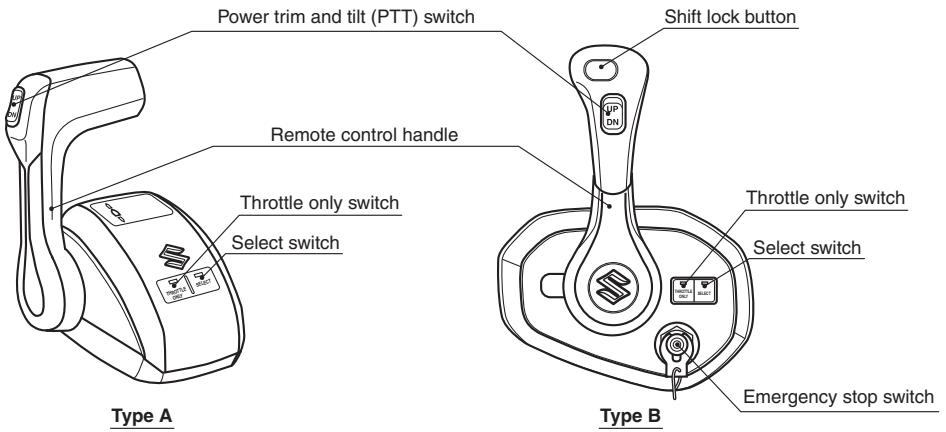

**Type A**

**Type B**

**REMOTE CONTROL BOX (Option)**

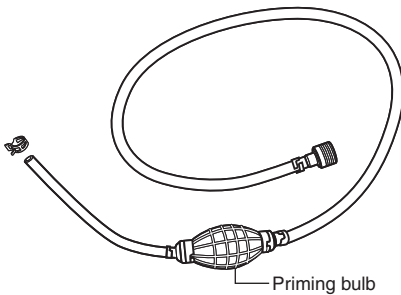

**FUEL LINE**

# MOTOR MOUNTING

## WARNING

Overpowering your boat can be hazardous. Excessive horsepower will have an adverse effect on hull safety and may cause operating/handling difficulties. The boat may also sustain stress and hull damage.

Never install an outboard motor with horsepower exceeding the manufacturer's recommended maximum horsepower listed on the boat's "Certification Plate". Contact your authorized Suzuki marine dealer if you are unable to locate the hull "Certificate Plate".

Suzuki strongly recommends that you have your outboard motor, controls and gauges installed by an authorized Suzuki Marine Dealer. He has the tools, the facilities and the know-how.

## WARNING

Failure to have your outboard motor and associated controls and gauges properly installed can result in personal injury or damage.

Suzuki strongly recommends that you have your outboard motor, controls and gauges installed by your authorized Suzuki marine dealer. He has the tools, the facilities, and the know-how to do the job correctly.

# BATTERY INSTALLATION

## BATTERY REQUIREMENTS

Do not use deep cycle batteries and gel-cell batteries for starting engines. Use a 12 Volt starting-type lead acid battery that meets the specifications shown below.

**650 Marine Cranking Amps (MCA)/ABYC, or 512 Cold Cranking Amps (CCA)/SAE or 160 Reserve Capacity (RC) Minutes/SAE or 12 Volt, 100 AH (20HR/IEC)**

### NOTE:

- *The specifications listed above are the minimum battery rating requirements for starting the engine.*
- *When connecting batteries in parallel, they must be of the same type, capacity, manufacturer, and of similar age. When replacement is necessary, they should be replaced as a set. Consult your Suzuki dealer for proper battery installation information.*
- *If your boat application requires additional battery loads, it is recommended that an auxiliary battery or batteries be installed. Consult your Suzuki dealer for proper battery installation information.*

## BATTERY INSTALLATION

Secure the battery in a dry area of the boat, away from vibration.

### NOTE:

- It is recommended that the battery be installed in an enclosed battery case.
- When connecting batteries, hexagon-nuts must be used to secure battery leads to battery posts.

To hook up the battery, first connect the red lead from the motor to the positive battery terminal, then connect the black lead to the negative battery terminal.

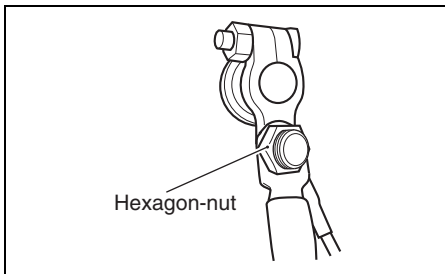
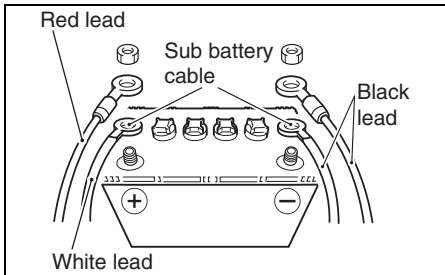

To remove the battery, first disconnect the black lead from the negative terminal, then disconnect the red lead from the positive terminal.

Suzuki recommends that you install the terminal cap on the positive battery terminal to prevent an accidental short circuit of battery terminals.

If a terminal cap is required, contact your authorized Suzuki marine dealer.

### ⚠ WARNING

If you place the battery near the fuel tank, a spark from the battery may ignite the gasoline, causing a fire and/or an explosion.

Do not place the fuel tank in the same compartment/area as the battery.

### ⚠ WARNING

Batteries produce flammable hydrogen gas and may explode if they are near flames or sparks.

Never smoke or cause sparks when working near the battery. Keep the battery away from open flames. To avoid creating a spark when charging the battery, connect the battery charger cables to the proper terminals before turning the charger on.

### ⚠ WARNING

Battery acid is poisonous and corrosive. It can cause severe injury and can damage painted surfaces.

Avoid contact with eyes, skin, clothing, and painted surfaces. If battery acid comes in contact with any of these, flush immediately with large amounts of water. If acid contacts the eyes or skin, get immediate medical attention.

### NOTICE

The electrical system or its components may be damaged if proper battery precautions are not followed.

- Be sure to attach battery leads correctly.
- Do not disconnect battery leads from the battery while the engine is running.

## SUB BATTERY CABLE

The sub battery cable ① is used to supply voltage to the engine control system. In the midst of the cable, a 30 A fuse ② is provided to protect the control circuit.

If the sub battery cable is not correctly connected to the battery, engine cannot be started.

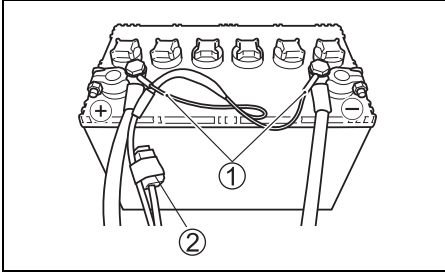

## USE OF ELECTRICAL ACCESSORIES

The amount of power (DC12V) available for accessories, however, depends on the operating condition of the motor. For getting a detailed information, please inquire of your authorized Suzuki Marine Dealer.

### NOTE:

*Use of too much power for electrical accessories under certain operating conditions can cause the battery to discharge.*

# SUZUKI KEYLESS START SYSTEM (IF EQUIPPED WITH KEYLESS START SYSTEM)

This system allows you to start the engine by means of communication between the keyless fob and the keyless control unit when you have the keyless fob with you, instead of using the mechanical key.

The engine can be started when the distance between the keyless fob and the keyless control unit is within the communication range of 1 m (40 in).

In this system, the keyless fob and the keyless control unit uses radio communication to check if the keyless fob ID is registered in the Keyless Start System.

If the keyless fob ID is not registered, the system prevents the engine from starting using the keyless fob.

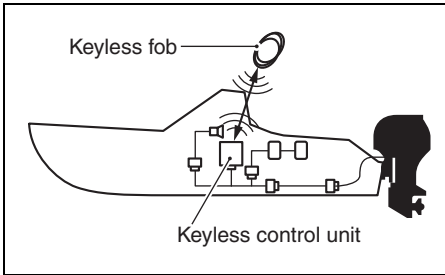

**NOTE:**  
*Please consult with a Suzuki Marine Dealer for the installation of the Keyless Start System.*

Also refer to the “Keyless Start System Instruction Manual” supplied with the product for detailed operating instructions.

## IMMOBILIZER SYSTEM

In this system, the keyless fob and the keyless control unit uses radio communication to check if the keyless fob ID is registered in the Keyless Start System.

If the keyless fob ID is not registered, the system prevents the engine from starting using the keyless fob.

## ▲ WARNING

Radio waves from the keyless control unit may interfere with the operation of electrical medical equipment such as pacemakers. Failure to take the precautions listed below can increase the risk of severe injury or death due to radio wave interference.

Anyone who uses electrical medical equipment such as a pacemaker should consult the medical equipment supplier to inquire if radio waves from the keyless control unit can interfere with the medical equipment.

## KEYLESS FOB

Two (2) keyless fobs are supplied with the Keyless Start System.

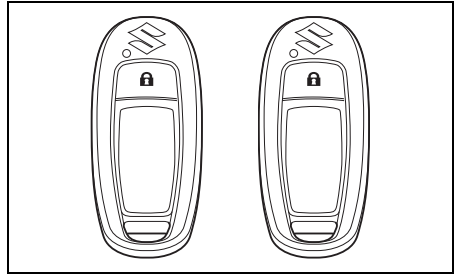

## ▲ WARNING

The keyless fob emits radio waves that may interfere with aircraft operations.

Do NOT operate the buttons on the keyless fob while you are in flight. When putting the keyless fob in a bag, etc., protect the buttons from accidentally being pressed.

**NOTE:**  
*The keyless fob falls under the category of restricted electronic devices for use in flight.*

### **NOTICE**

The radio waves emitted from the keyless fob may cause interference with other wireless communication devices such as mobile phones and remoter controllers.

Do not operate the buttons on the keyless fob more than necessary.

### **▲ CAUTION**

Attempting to disassemble (except for battery replacement), repair, or modify the keyless fob may cause ignition, electric shock, or injury.

Do NOT attempt to disassemble (except for battery replacement), repair, or modify the keyless fob.

### **NOTICE**

The keyless fob is comprised of sophisticated electronic components that can become damaged and may fail to function properly if you do not take proper precaution.

- Do NOT leave it in places that may reach a high temperature.
- Do NOT apply a strong impact, such as dropping it.
- Do NOT bring it close to any magnetic objects.
- Do NOT place it near any electro-magnetic devices such as a television or audio equipment.
- Do NOT place it near any electric medical equipment (microwave therapy equipment, low frequency therapy equipment, etc.), or receive medical treatment with the keyless fob in your pocket, etc.

### **NOTE:**

- Do NOT erase or tamper with the conformance certification mark.
- A maximum of six (6) keyless fobs can be registered in one keyless control unit.
- The battery life of the keyless fob is about two (2) years, which can vary depending on use.
- The keyless fob is always in transmission mode in order to communicate with the keyless control unit. For this reason, the battery may run down quickly if it receives strong radio waves from televisions or personal computers, etc.

### **NOTE:**

- If the keyless fob is lost, immediately contact your authorized Suzuki Marine Dealer.
- The keyless fob uses a weak radio wave that is susceptible to external influences when it communicates with the keyless control unit. For this reason, it may not operate properly under the following use environment.
  - There is a nearby facility that emits strong radio waves such as a television tower, electric power plant, or broadcasting station, etc.
  - The keyless fob is held close to other wireless communication devices such as mobile phone, radio equipment or a laptop personal computer.
  - The keyless fob is in contact with or covered with a metallic object.

## Switching the communication mode of the keyless fob

Press and hold the lock button ① on the keyless fob for more than one second to switch between ON mode and OFF mode.

ON mode:

The Keyless Start System can be used.

OFF mode:

The Keyless Start System cannot be used.

**NOTE:**

If the lock button is pressed briefly while in communication ON mode, the LED ② on the keyless fob briefly flashes once.

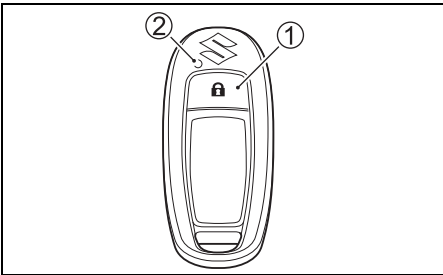

## KEYLESS FOB BATTERY REPLACEMENT

### ⚠ WARNING

The keyless fob contains a coin/button cell battery.

- The battery is hazardous and is to be kept away from children and pets (whether the battery is new or used).
- The battery can cause severe or fatal injuries in 2 hours or less if it is swallowed or placed inside any part of the body.
- Medical attention should be sought immediately, if it is suspected that the battery has been swallowed or placed inside any part of the body.
- Stop using the keyless fob, if the keyless fob cover does not close firmly.

### ⚠ CAUTION

- There is a danger of explosion if the battery is replaced with an incorrect type. Only replace the battery with the same or equivalent type.
- Please check and obey all local laws and regulations for the disposal of batteries or accumulations. Never dispose of battery in fire or mechanical crushing or cutting. If battery is incorrectly discarded or heated to high temperature 100 °C (212 °F) or higher, gas may be generated inside battery, causing electrolyte leak, internal short circuit, heat generation, explosion and violent flaring.
- Do not expose the keyless fob or its' battery to excessive heat such as direct sunlight or fire.

### NOTICE

To prevent damage to the keyless fob, be careful when replacing the battery.

- Install the lithium disc-type battery with the electrodes facing the proper direction.
- Do NOT touch the internal circuit of the keyless fob when replacing the battery.

If the keyless fob battery runs low, "Keyless FOB Battery Low" appears on the gauge, which indicates the battery should be replaced.

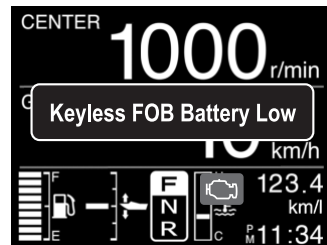



To replace the keyless fob battery:

1. Insert a flat blade screwdriver in the slot of the keyless fob and remove the cover.

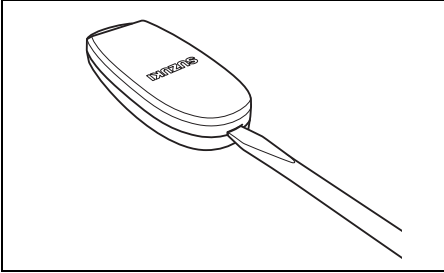

2. Remove the O-ring ①.

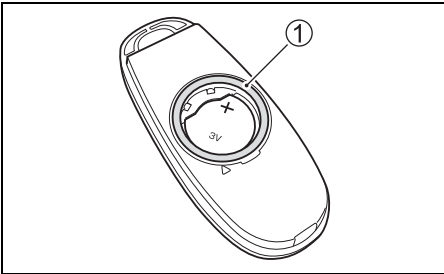

**NOTE:**

*The O-ring may be fitted on the cover side.*

### **NOTICE**

**If the O-ring is damaged, the waterproof performance deteriorates, which can cause the keyless fob to malfunction.**

**Be careful not to damage the O-ring when removing it.**

3. Insert a flat blade screwdriver into the slot at the  $\Delta$  mark on the cover to remove the battery.

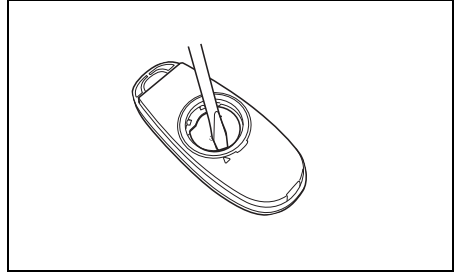

4. Replace the battery so its  $\oplus$  terminal faces the cover side as shown in the illustration. Lithium disc type battery: CR2025 or equivalent. Confirm that the O-ring is placed in position on the body side.

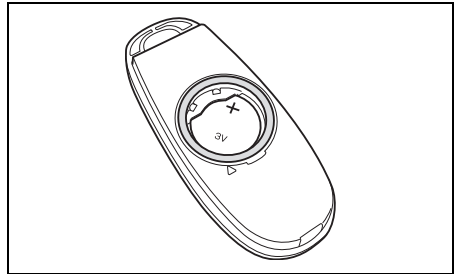

5. Reinstall the cover.

# PROPELLER SELECTION AND INSTALLATION

## PROPELLER SELECTION

It is essential to use a propeller on your outboard motor that is properly matched to your boat's operating characteristics. The speed of the engine when you operate your boat at full throttle depends on the propeller you use.

Excessive engine speed can seriously damage the motor, while low engine speed at full throttle will adversely affect the performance. Your operating load will also affect propeller selection. Smaller loads generally require larger-pitch propellers; larger loads generally require smaller-pitch propellers. Your authorized Suzuki Marine Dealer will assist you in selecting a suitable propeller for your boat.

### NOTICE

Installing a propeller with either too much or too little pitch will cause incorrect maximum engine speed, which may result in severe damage to the motor.

Ask your authorized Suzuki marine dealer to assist you in selecting a suitable propeller for your boat.

You can determine if your propeller is appropriate for use with your boat by using a tachometer to measure engine speed when operating your boat at full throttle, under minimum load conditions. If you are using an appropriate propeller, the engine speed will be within the following range:

Full throttle operating range	DF115BG	5000 – 6000 r/min. (min <sup>-1</sup> )
	DF140BG	5700 – 6300 r/min. (min <sup>-1</sup> )

If the engine speed is not within this range, consult your authorized Suzuki Marine Dealer to determine which propeller size is best for you.

## PROPELLER INSTALLATION

### ▲ WARNING

Failure to take proper precautions when installing or removing the propeller can result in severe personal injury.

When installing or removing the propeller:

- Always shift into “Neutral” and remove the emergency stop switch lock plate so that the motor cannot be started accidentally.
- Wear gloves to protect hands, and “lock” the propeller by placing a block of wood between the blades and the anti-cavitation plate.

To install a propeller on your outboard motor, use the following procedure:

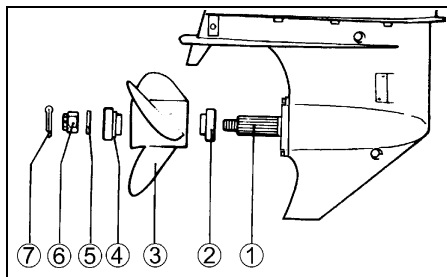

1. Coat the propeller shaft splines ① liberally with Suzuki water resistant grease to help prevent corrosion.
2. Place the stopper ② on the shaft.
3. Align the propeller ③ with the propeller shaft splines and slide the propeller onto the shaft.
4. Place the spacer ④ and washer ⑤ on the shaft.
5. Install the propeller nut ⑥ and tighten it with a torque wrench to 50 – 60 N·m (5.1 – 6.1 kgf-m/37 – 44 lbf-ft).
6. Install the cotter pin ⑦ and bend it so that it can't come off.

To remove the propeller, reverse the above procedure.

# ADJUSTMENT

## TRIM ANGLE ADJUSTMENT

To help maintain steering stability and good performance, always maintain the proper trim angle as shown in the illustration. The appropriate trim angle varies depending on the combination of the boat, engine, and propeller, as well as operating conditions.

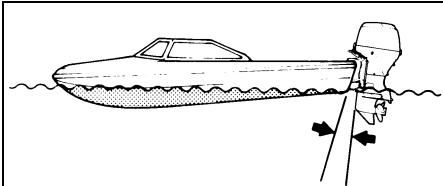

- Trim angle too small (Boat tends to “plow”)

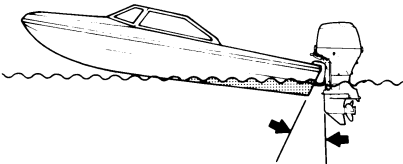

- Trim angle too large (Boat tends to “porpoise”)

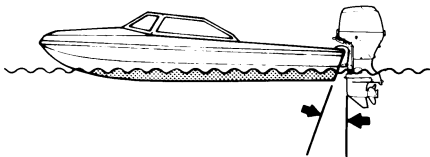

- Proper trim angle

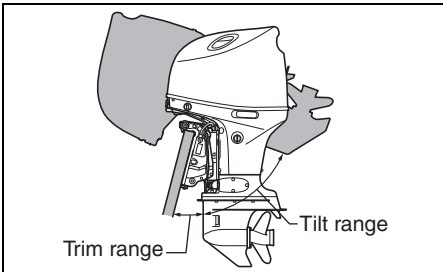

## ▲ WARNING

Trim angle greatly affects steering stability. If the trim angle is too small, the boat may “plow” or “bow steer”. If the trim angle is too large, the boat may “chine walk” from side to side or “porpoise” up and down. These conditions, which result in loss of steering control, can cause occupants to be thrown overboard.

Always maintain proper trim angle based on the combination of your boat, engine, and propeller, as well as operating conditions.

## ▲ WARNING

When the motor is tilted beyond the maximum trim position, the swivel bracket will not have side support from the clamp bracket and the tilt system will be unable to cushion the engine if the lower unit strikes an obstruction. This could lead to occupant injury.

Do not operate the engine above 1500 r/min or operate the boat in a planing attitude with the motor tilted beyond the maximum trim position.

## NOTICE

If you operate the boat with the motor trimmed beyond the maximum trim position, the water intake holes may be above the water line, causing severe engine damage due to overheating.

Never operate the boat with the motor trimmed beyond the maximum trim position.

Make a test run in the boat to determine if the trim angle needs to be adjusted. Adjust the trim angle using the Power Trim and Tilt system. Refer to the POWER TRIM AND TILT section.

If you still cannot achieve good performance, there may be a problem with engine mounting height. Consult your dealer for assistance.

### Automatic trim angle adjustment

This outboard motor is equipped with automatic trim angle adjustment function. The function automatically adjusts the trim angle appropriately. Refer to Auto Trim in METER (OPTION) MULTI-FUNCTION GAUGE section.

### TRIM TAB ADJUSTMENT

This adjustment is used to compensate for the possible tendency of your boat to veer slightly to port or starboard. This tendency could be due to such things as propeller torque, motor mounting position, etc.

To adjust the trim tab:

1. Loosen the bolt (A) that holds the trim tab in place.

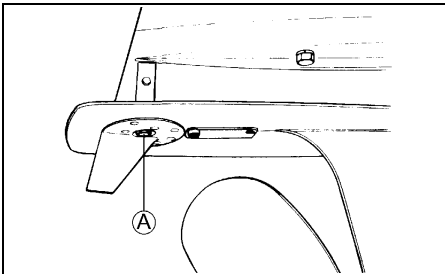

2. If the boat tends to veer to port, move the rear end of the trim tab toward the port side. If the boat tends to veer to starboard, move the starboard side.

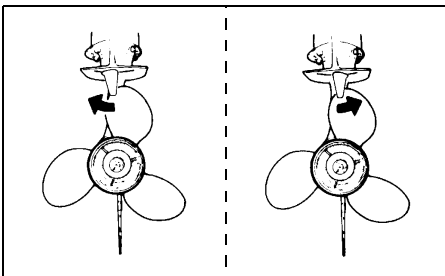

3. Tighten the bolt that holds the trim tab in place.

After adjusting the trim tab, check to see if the boat still tends to veer to one side. If necessary, readjust the trim tab.

### CONTROL HANDLE ADJUSTMENT

The control handle friction and control handle detent force can be adjusted to suit operator's preference. The control handle friction adjustment will change the overall effort to move the control handle. This will help prevent undesired movement of the control handle in rough water conditions. Consult your authorized Suzuki marine dealer to adjust the control handle friction and detent force.

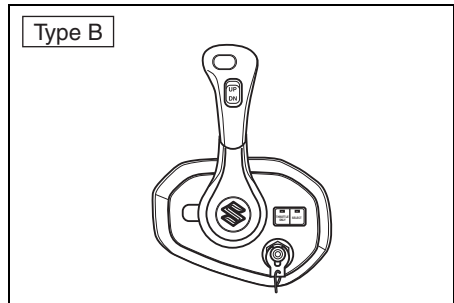
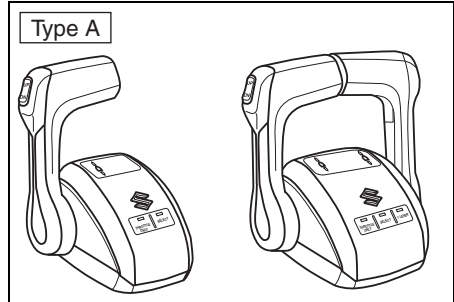

Type	Adjustable item
A	Friction and detent force
B	Friction

### IDLE SPEED ADJUSTMENT

The idle speed has been factory adjusted between 650 – 750 r/min in neutral.

#### NOTE:

*If idle speed cannot be set within the specified range, contact your authorized Suzuki Marine Dealer.*

## SETTING OF TILT UPPER LIMIT POSITION

If the outboard motor contacts the motor well of the boat during full tilt up operation, the upper limit setting should be reset.

Perform this set-up after the current position setting has been canceled, as explained in the following procedure.

### CANCELING THE TILT UPPER POSITION LIMIT SETTING

1. If equipped with Keyless Start System:  
Press and hold the engine switch ① for more than two seconds to turn on the power.

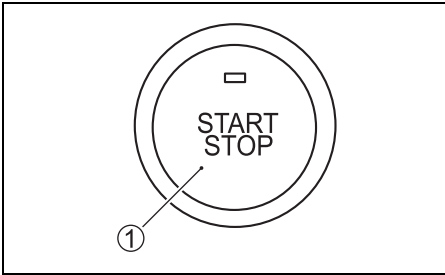

If not equipped with Keyless Start System:  
Turn the ignition key to the "ON" position.

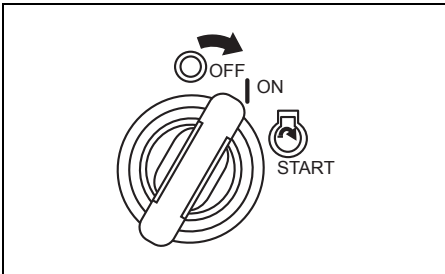

2. Pull out the emergency stop switch lock plate ②.

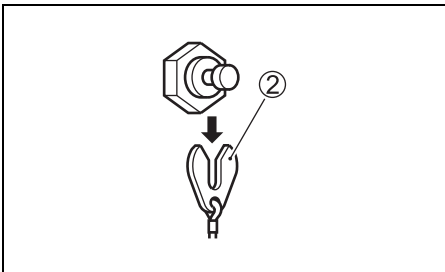

3. Make sure that remote control handle is in "NEUTRAL".
4. Confirm the select LED lights, if not, depress the select switch on the remote control box. Depress the "THROTTLE ONLY" button ③.

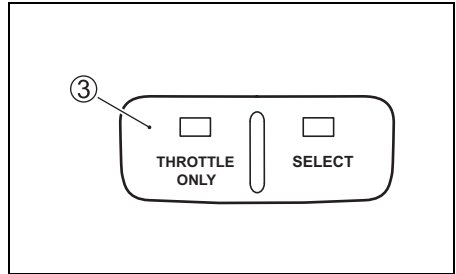

5. Move the control handle forward until the caution buzzer sounds one time. At this time, the message of "Set Limit Angle" will appear on the gauge screen. Press the "UP" side of the PTT switch for three seconds and the buzzer will sound twice briefly indicating the setting has been canceled.

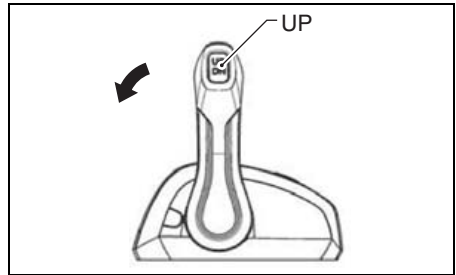

6. Return the throttle to the fully closed position.

### SETTING THE TILT UPPER POSITION LIMIT

1. If equipped with Keyless Start System:  
Press and hold the engine switch for more than two seconds to turn on the power.  
  
If not equipped with Keyless Start System:  
Turn the ignition key to the "ON" position.
2. Press the "UP" side of the PTT switch so that the optimum full tilt up position for the boat can be obtained.
3. Pull out the emergency stop switch lock plate.

4. Make sure that remote control handle is in "NEUTRAL".
5. Confirm the select LED lights, if not, depress the select switch on the remote control box. Depress the "THROTTLE ONLY" button.
6. Move the control handle forward until the caution buzzer sounds one time.
7. Press the "UP" side of PTT switch three times within three seconds. The buzzer will sound one time briefly indicating the setting has been accepted.
8. Return the throttle to the fully closed position and install the lock plate on the emergency switch. Operate the full tilt up and full down operations several times by pressing the PTT switch and check that the setting of the tilt upper limit is properly set.

### **⚠ WARNING**

Setting of the tilt upper limit position will not prevent the outboard motor from tilting fully up and contacting the motor well if the motor's lower unit hits an object at high speed. Such tilting could damage your motor and boat and injure the boat occupants.

Keep all occupants away from the motor when operating at high speed.

## **MOTOR COVER FASTENING ADJUSTMENT**

If you feel motor cover fastening is loose or too tight when locking the levers, adjust as follows:

1. Loosen the bolts ①, ② and ③.
2. Adjust the position of brackets ④, ⑤ and ⑥. To increase the fastening, move the brackets to the direction ①. To decrease the fastening, move the brackets to the direction ②.
3. Tighten the bolts.

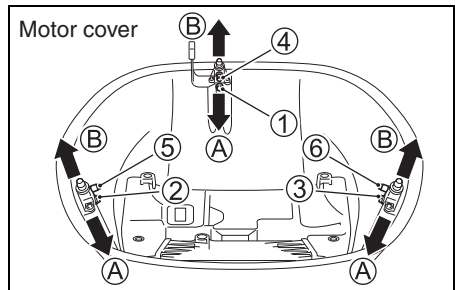

# METER (OPTION) MULTI-FUNCTION GAUGE

This gauge is multifunctional gauge that displays the various information through digital communication with the engine. Information displayed are engine speed, shift position, fuel level, fuel consumption, etc.



**NOTE:**  
There is information that cannot be displayed depending on the model and equipment.

**NOTE:**  
Consult your authorized Suzuki marine dealer for setting up the multi-function gauge.

**NOTE:**  
For details the proper handling of the multi-function gauge, refer to "OPERATION INSTRUCTION MANUAL" packed in the gauge.

**NOTE:**  
The navigation data on this gauge should be used only for your reference. When exact navigation information is required, use nautical charts and/or accurate navigation instruments together with the multi-function gauge.

## BUTTON FUNCTIONS

The multi-function gauge has four buttons: [MENU], [▼], [▲], and [SET].



The function of each button is as follows. The [MENU] button gives you access to the menu screen.

**NOTE:**  
Pressing and holding the [MENU] button can transfer the mode to the TROLL mode.

Use the [▼] and [▲] buttons to move the selection cursor, select sub information, and adjust information input.

**NOTE:**  
Press and hold either the [▼] or [▲] button to reset the trip time, trip distance, average fuel consumption, and total fuel consumption in the sub information simultaneously. The [SET] button is used to decide the selectable item.

**NOTE:**  
Pressing and holding the [SET] button, can change the illumination for the gauge screen to that for the daytime or nighttime.

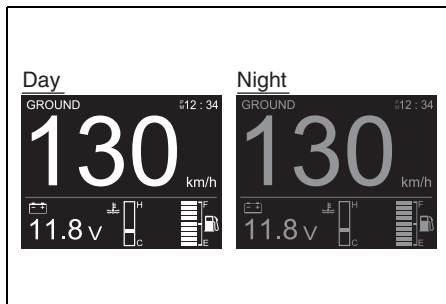

## SCREEN SELECTION

The multi-function gauge can select the display screen from the following choices.

- Engine Speed
- Ground Speed/Fuel Information
- Fuel Information
- All Items Display Screen (Full Item)

### To select the display screen:

Press the [SET] button and select the desired display screen.

Every time the [SET] button is pressed, the display screen switches in the following sequence.

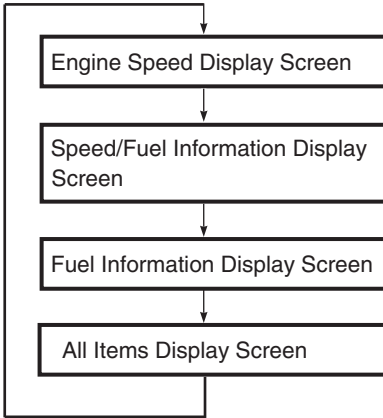

### NOTE:

Screens that had been set to "OFF" in the display setting are not displayed and the display skips to the next screen. (Refer to the MENU INFORMATION SELECTION section)

## 1. Engine Speed Display Screen

The engine speed ①, shift position ②, time ③, engine position ④ and sub information ⑥ are displayed.

The sub information display can be switched by pressing the [▼] or [▲] buttons.

This screen can be selected between digital and analog display. (Refer to the MENU INFORMATION SELECTION section)

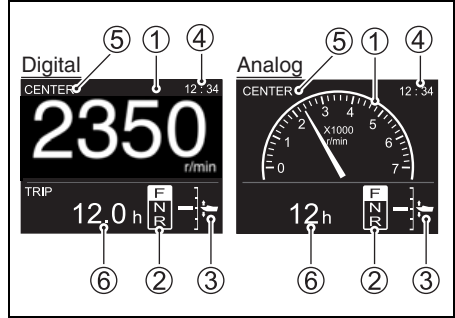

## 2. Speed/Fuel Information Display Screen

The speed ①, fuel level ②, sub information ③ and time ④ are displayed.

The sub information display can be switched by pressing the [▼] or [▲] buttons.

This screen can be selected between digital and analog display. (Refer to the MENU INFORMATION SELECTION section)

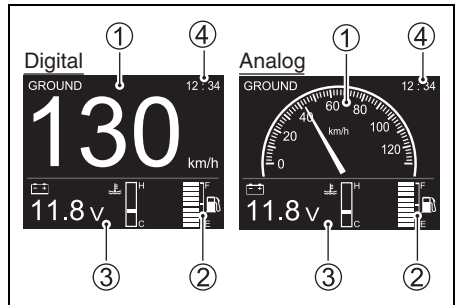



### 3. Fuel Information Display Screen

This screen indicates the remaining fuel levels of each tank installed, along with sub information.

The sub information display can be switched by pressing the [▼] or [▲] buttons.

This screen indicates only in digital mode.

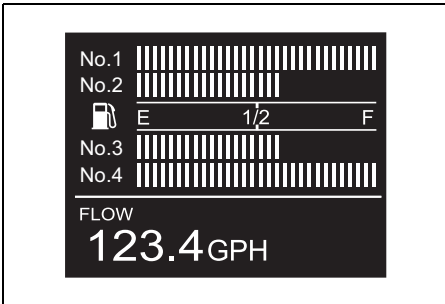
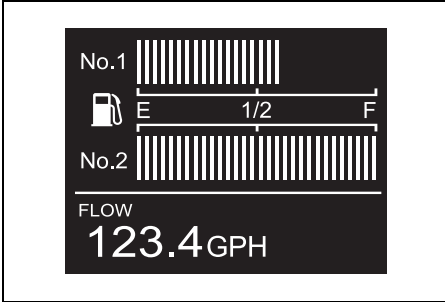

### 4. All Items Display Screen

This screen displays all the general indication items for this gauge.

This screen can be selected between digital, analog1 and analog2 display. (Refer to the MENU INFORMATION SELECTION section)

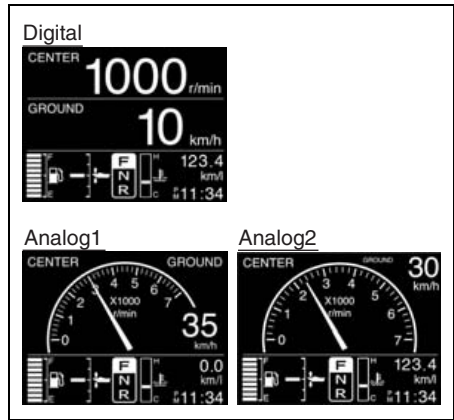

### SUB INFORMATION SELECTION

When the Engine Speed, Ground Speed/Fuel Information or Fuel Information screen is displayed, press the [▼] or [▲] button to switch the sub Information display in the following sequence.

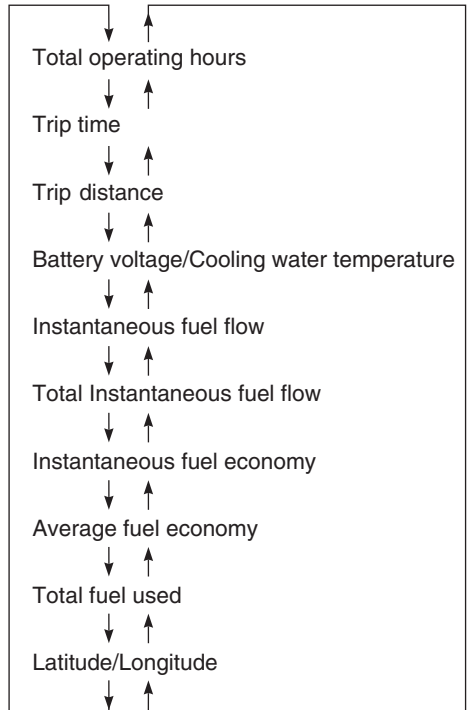

**NOTE:**

Press and hold either the [✓] or [^] button to reset the trip time, trip distance, average fuel consumption, and total fuel consumption in the sub information simultaneously. All other items are also reset simultaneously, in addition to the displayed item.

**1. Total Operating Hours**

The total operating hours from brand-new engine are displayed.



**2. Trip Time**

This screen indicates the trip time since it was reset last time.



**3. Trip Distance**

This screen indicates the trip distance since it was reset last time.

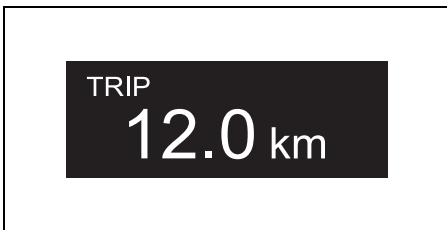

**4. Battery Voltage/Cooling Water Temperature**

The cooling water temperature and battery voltage are displayed.

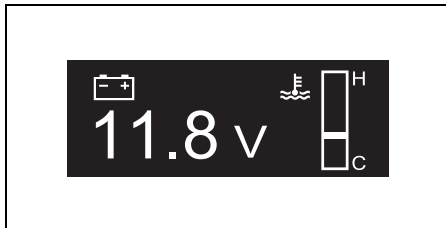

**5. Instantaneous fuel flow**

This screen indicates the instantaneous fuel flow of each outboard motor.

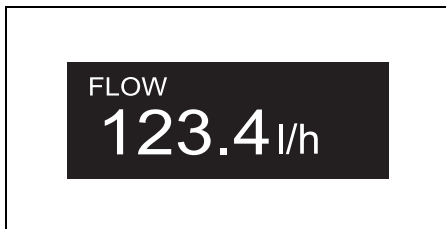

**6. Total Instantaneous fuel flow**

This screen indicates the total instantaneous fuel flow of all outboard motors installed.

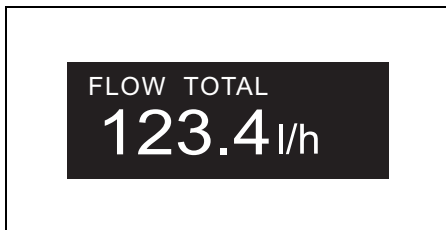

**7. Instantaneous fuel economy**

This screen indicates the total instantaneous fuel economy of all outboard motors installed.

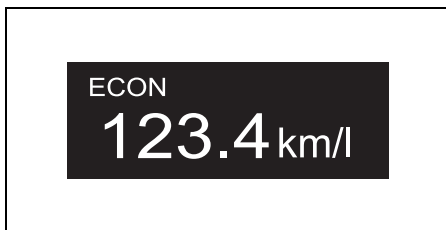

### 8. Average fuel economy

This screen indicates the total average fuel economy of all outboard motors installed.

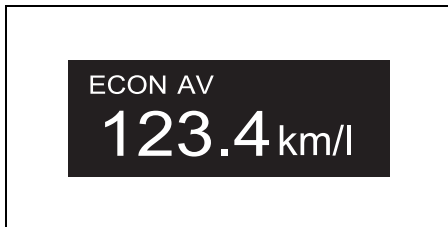

### 9. Total fuel used

This screen indicates the total fuel used of all outboard motors installed.

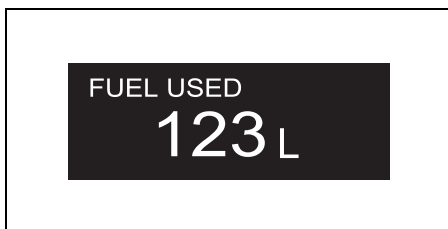

### 10. Latitude/Longitude

The latitude and longitude of current boat position are displayed.

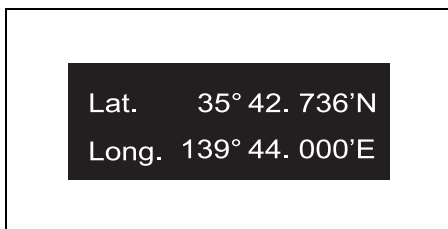

#### NOTE:

If the "Latitude/Longitude" are not displayed, confirm the connection of the GPS receiver and confirm the radio wave receiving condition.

## MENU INFORMATION SELECTION

The menu screen is displayed when the MENU button is pressed while any screen is displayed. While the menu screen is displayed, press the MENU button to return to the previous screen. The MENU has four items of [Illumination], [Diagnosis], [Display], and [Initial Setting].

Press the [▼] or [▲] button to select a menu item.

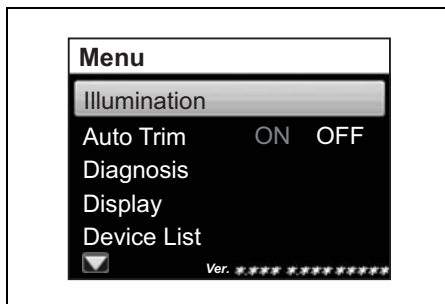

### 1. Illumination

Press the [▼] or [▲] button to select "Illumination" and then press the [SET] button to display the Illumination selection menu.

### Brightness

The screen brightness can be adjusted in 10 steps.

Press the [▼] or [▲] button to select "Brightness" and press the [SET] button. Next, adjust the brightness using the [▼] or [▲] button and then press the [SET] button.

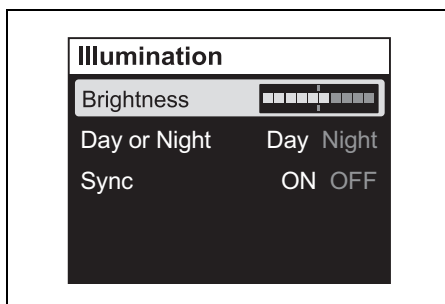

## Day or Night

Press the [▼] or [▲] button to select “Day or Night”. Next, select “Day” or “Night” using the [SET] button.

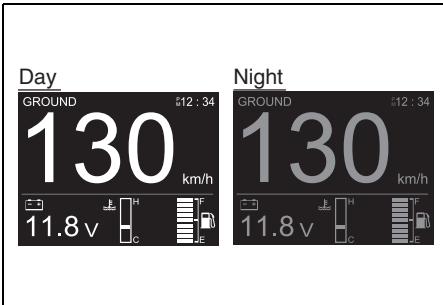
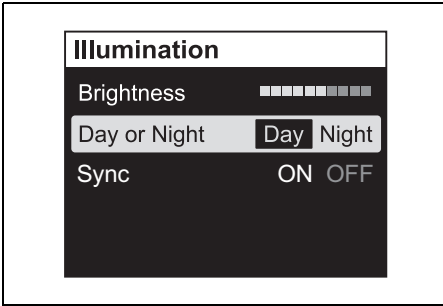

## Sync

The “Brightness” setting is synchronized with the “Day or Night” setting for the two or more gauges where “ON” has been selected in the “Sync” setting.

Press the [▼] or [▲] button to select “Sync”. Next, select “ON” (synchronous) or “OFF” (asynchronous) using the [SET] button.

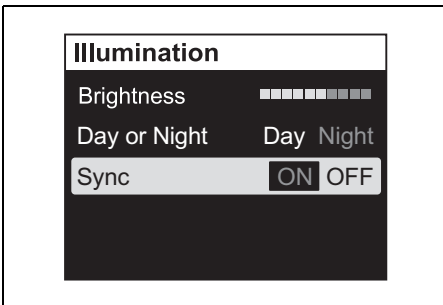

## 2. Auto Trim

Sets the Auto Trim mode.

Set the outboard motor to the full trim down position. Use the [▼] or [▲] buttons to select “Auto Trim”, and press the [SET] button.

Next, press the [SET] button to select either “ON” or “OFF”.

When the Auto Trim mode is ON, an “A” is displayed on the multi-function gauge screen.

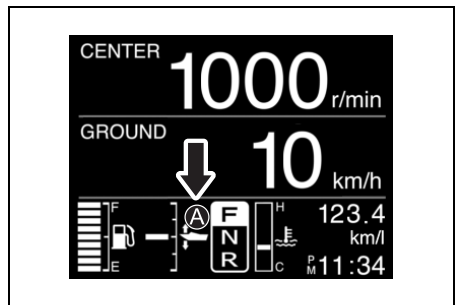
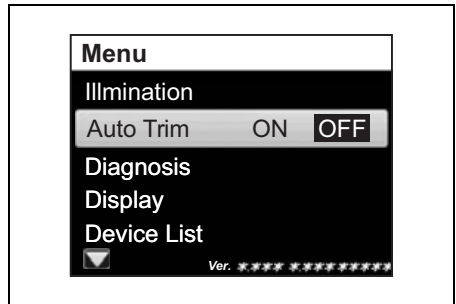
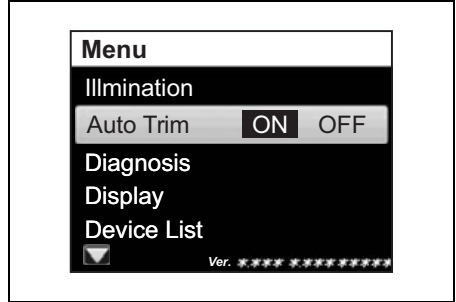

**NOTE:**

- “A” is not displayed if the trim position does not appear on the multi-function gauge screen.
- The PTT switch operations take priority, even when the Auto Trim mode is set “ON”.
- If the PTT switch is operated when the Auto Trim mode is set “ON”, the Auto Trim mode is interrupted and the “A” flashes on the display. Auto Trim mode engages again when the engine speed is reduced to 1500 r/min or below or the outboard motor is set in the full trim down position.

**3. Diagnosis**

Press the [▼] or [▲] button to select “Diagnosis” and then press the [SET] button to display the Diagnosis selection menu.

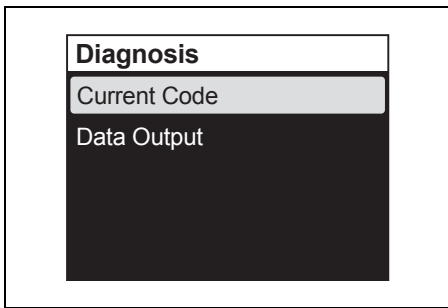

**Current Code**

Press the [▼] or [▲] button to select “Current Code” and, then press the [SET] button to display the diagnostic code and/or caution message that are currently activated.

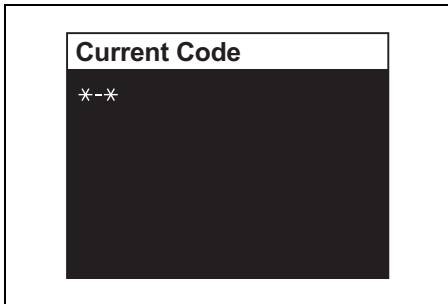

(Refer to the CAUTION SYSTEM and DIAGNOSTIC SYSTEM section)

**Data Output**

**NOTE:**

For details the proper handling of the multi-function gauge, refer to “OPERATION INSTRUCTION MANUAL” packed in the gauge.

Press the [▼] or [▲] button to select “Data Output” and then press the [SET] button to display the Data Output selection menu.

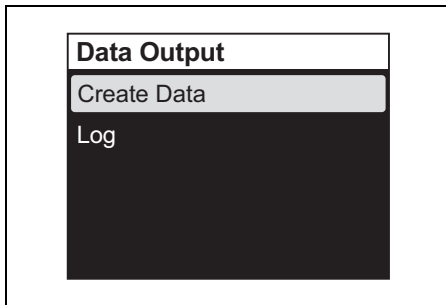

**Create Data:**

The “Create Data” items (engine oil change frequency, total operation hours, etc.) can be checked.

**Log:**

The “Create Data” items (engine oil change frequency, total operation hours, etc.) obtained and saved before, can be checked.

**4. Display**

While [Display] is selected, press the [SET] button to display the selection menu for Digital indication “D”, Analog indication “A”, and indication OFF.

Select the display item using the [▼] or [▲] button. Then, press the [SET] button to select “A1”, “A2”, “D” or “OFF”.

As the “Fuel” screen displays only in digital mode, the available selection is either “ON” or “OFF.”

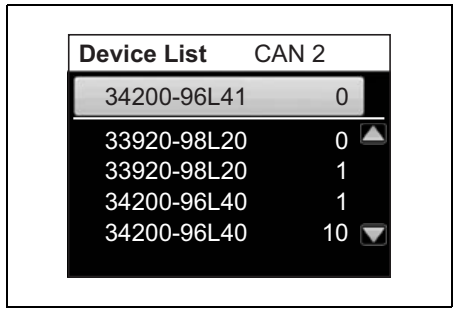
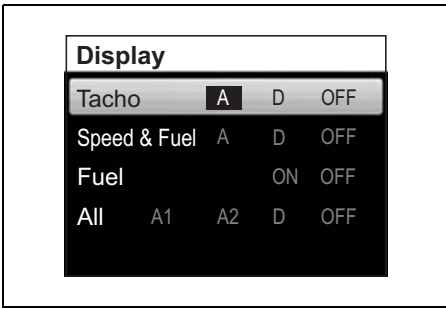

When the indication is set to “OFF”, the display screen for that item is skipped and the next screen is displayed. (Refer to the SCREEN SELECTION section)

**NOTE:**

*It is not possible to set all the display items to OFF (hidden). Please set at least one (1) display item to be displayed.*

**5. Device list**

Displays a list of the devices connected to the multi-function gauge.

Use the [▼] or [▲] buttons to select “CAN2” and press the [SET] button to display the multi-function gauge information and information about the devices connected to the multi-function gauge (such as other multi-function gauges).

Use the [▼] or [▲] buttons to select “EXTERNAL” and press the [SET] button to display the multi-function gauge serial number and information about the devices connected to the NMEA line (such as the GPS module).

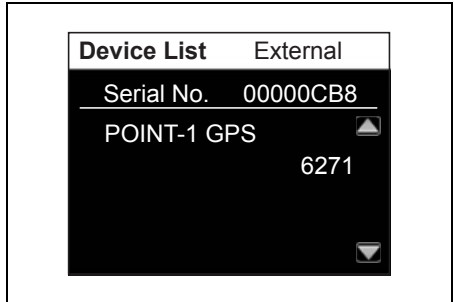
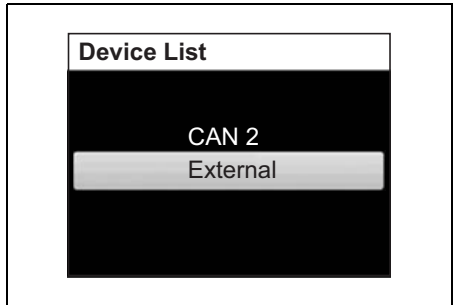
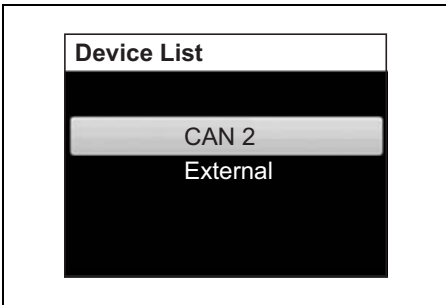

## 6. Keyless

You can display the Keyless Start System passcode. You can also change the passcode.

(1) If you have the keyless fob

- Confirm the keyless fob is within the communication range of the Keyless Start System.
- Confirm that the keyless fob is in communication ON mode. (Refer to “Switching the communication mode of the keyless fob” section.)
- Press the [▼] or [▲] button to select “Keyless” and then press the [SET] button to display the Keyless selection menu.

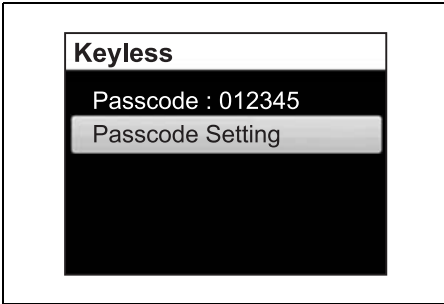

### Passcode

The passcode appears.

### Passcode Setting

Press the [SET] button.

Enter a 6-digit passcode.

Use the [▼] or [▲] buttons to select a number for each digit.

Press the [SET] button to move to the next digit.

Press the [MENU] button to return to the previous digit.

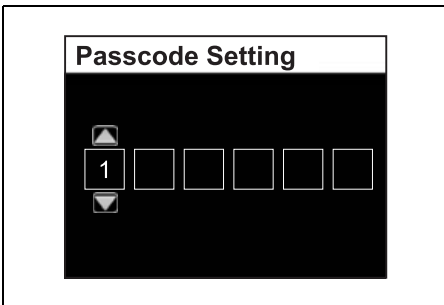

Passcode appears once the [SET] button is pressed after you have entered all 6 digits.

(2) If you do not have the keyless fob

When the keyless start system starts up, enter your passcode, and you can change it within 1 minute after unlocking.

## 7. Initial Setting

Items in the Initial Setting include important items for initial setting. Therefore, the confirmation screen “Revise initial setting?” is displayed when you select “Initial Setting” in the menu screen and press the [SET] button. To change the Initial Setting, select “Yes” using the [▼] or [▲] button and press the [SET] button to display the Initial Setting menu screen.

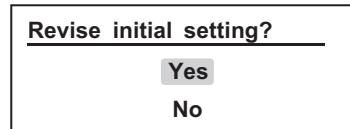

“Initial Setting” contains eight (8) menus.

Select the Initial Setting menu using the [▼] or [▲] button, and then press the [SET] button to display the setting screen.

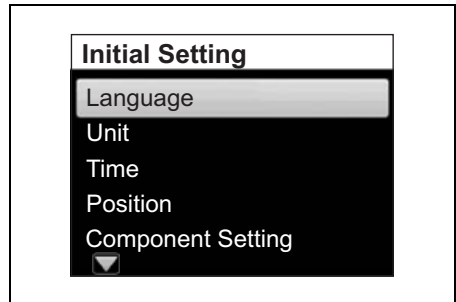

### Language

Sets the display language.

Use the [▼] or [▲] button to select the display language, and press the [SET] button.

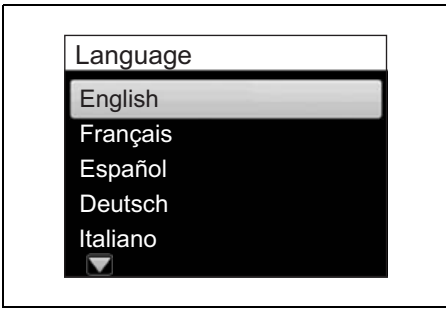

The confirmation message appears. To change the display language, use the [▼] or [▲] button to select “YES”, and press the [SET] button. If you do not want to change the language, select “NO”, and press the [SET] button.

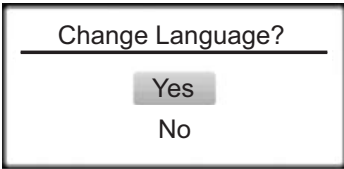

**Unit**

Setting for the following units.  
 Distance: set the unit for distance.  
 Press the [SET] button to select the unit.

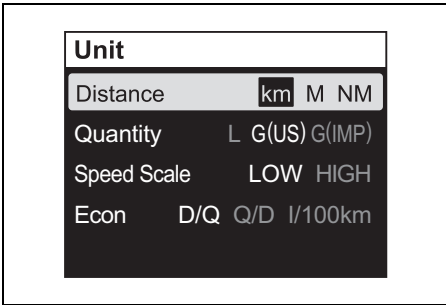

Quantity: set the unit for fuel quantity.  
 Press the [SET] button to select the unit.

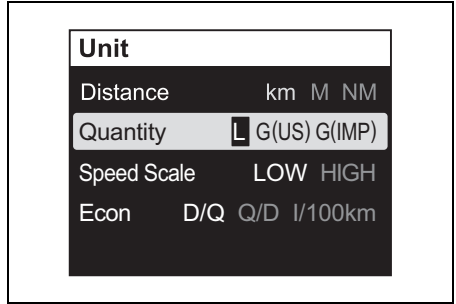

Speed Scale: setting for the speed scale.  
 The setting of Speed Scale is reflected only on the analog screen display.  
 Press the [SET] button to select the scale to be indicated.

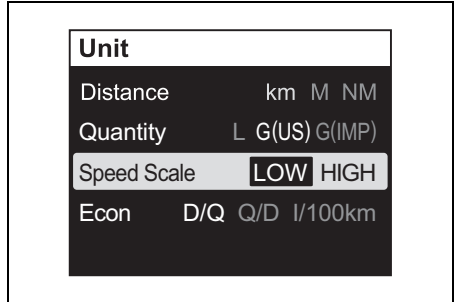

Econ: set the unit for fuel economy.  
 Press the [SET] button to select the unit.

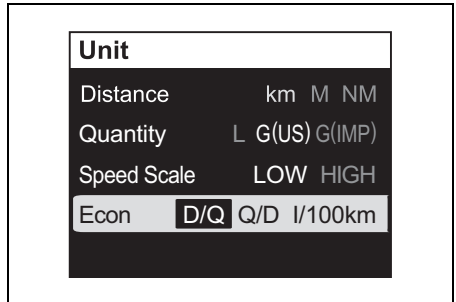



## Time

Setting for the time indication.

Clock: setting for display/non-display of the clock.

Press the [SET] button to select "ON" or "OFF."

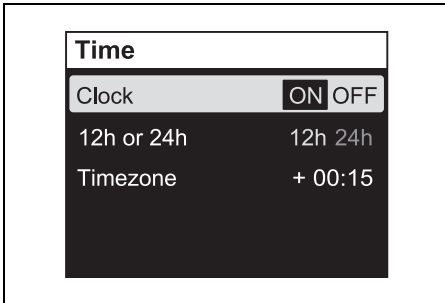

12h or 24h: select 12-hour or 24-hour display. Press the [SET] button to select "12h" or "24h."

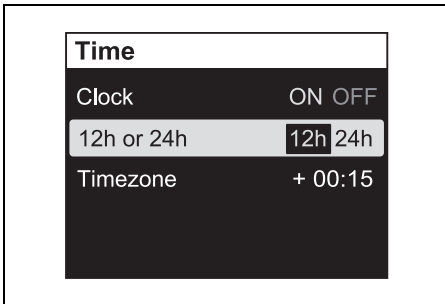

Timezone: set the time zone.

This gauge can be set the time by entering the time difference from the standard time (Greenwich time). After the time difference is entered, it is not required to enter it again.

Time can be set in the range of +14:00 from -12:00.

Press the [SET] button to activate the input position, and adjust the time difference using the [✓] or [^] button.

Press the [✓] or [^] button briefly to change the time in 15-minute increment. Press and hold the button to change the time continuously by 15 minutes.

## NOTE:

If the "Timezone" is not displayed, confirm the connection of the GPS receiver.

If a GPS receiver is not installed, the screen displays "--:--".

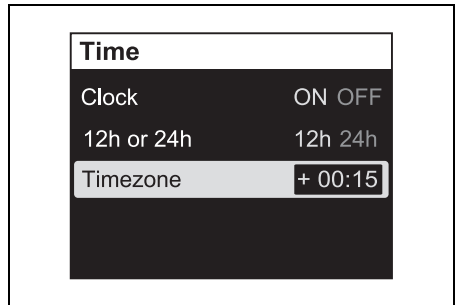

## Position

Setting for the gauge and engine position.

Consult your authorized Suzuki marine dealer for setting change of "Position".

## Component Setting

Settings for component.

Consult your authorized Suzuki marine dealer for setting change of "Component Setting".

## Tank

Setting for fuel tanks.

Consult your authorized Suzuki marine dealer for setting change of "Tank".

## Keyless Setting

Setting for Keyless.

Consult your authorized Suzuki marine dealer for setting change of "Keyless Setting".

## Demo Mode Setting

Setting for Demo Mode.

Consult your authorized Suzuki marine dealer for setting change of "Demo Mode Setting".

## ALARM

Alarms alert the user of an operating condition that requires action. If an alarm occurs, the gauge screen will display the caution message and the caution alarm icon immediately.

The caution message clears when any of the buttons are pressed on the gauge. However, the caution alarm icon is displayed until eliminating the cause. The buzzer sound also stops when the cause is eliminated.

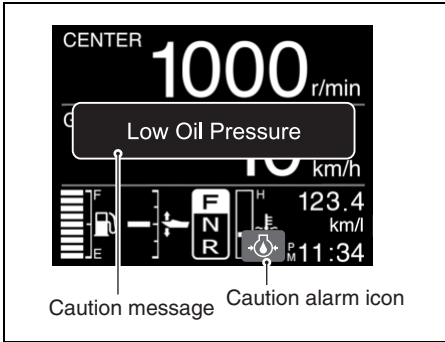

## CAUTION SYSTEM

The caution systems are designed to alert you to certain situations which may cause damage to your outboard motor.

### NOTICE

**Your outboard motor may become damaged if you rely on the Caution System to alert you to any malfunction that may occur or to give you an indication of the need for maintenance.**

**To avoid damage to your outboard motor, regularly inspect and maintain it.**

### NOTICE

**Continuing to operate your outboard motor with the Caution System activated can result in severe damage to your outboard motor.**

**If the Caution System activates while you are operating your outboard motor, stop the motor as soon as possible and correct the problem or consult your authorized Suzuki marine dealer for assistance.**

## INDICATOR CHECK

If equipped with Keyless Start System:

Each time you press and hold the engine switch for at least 2 seconds to turn on the system, the alarm buzzer sounds for 2 seconds.

### NOTICE

**If the Caution System is not working properly, you may not be alerted to a condition that can cause damage to your outboard motor.**

**If the buzzer does not sound when the Keyless Start System has been turned to ON state by operating the engine switch, the buzzer may be broken or a failure may exist in the system circuit. Consult your authorized Suzuki marine dealer.**

If not equipped with Keyless Start System:  
Each time the ignition key is turned to the “ON” position, the alarm buzzer will sound for 2 seconds.

**NOTICE**

If the Caution System is not working properly, you may not be alerted to a condition that can cause damage to your outboard motor.

If the buzzer does not sound when the ignition key is turned to the “ON” position, the buzzer may be broken or a failure may exist in the system circuit. Consult your authorized Suzuki marine dealer.

**OVER-REVOLUTION CAUTION SYSTEM**

This system is activated when engine speed exceeds maximum recommended speed for more than 10 seconds. In addition, “Rev Limit” is displayed on screen.

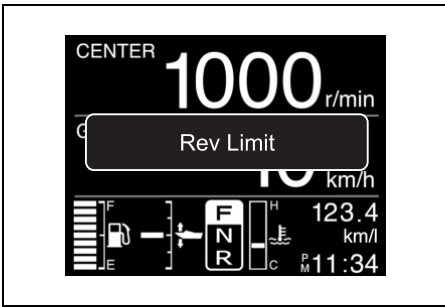

If you continue to run, engine speed will automatically be reduced to approximately 3000 r/min, simultaneously the buzzer sounds. Then the display will be changed into “Over Revolution”.

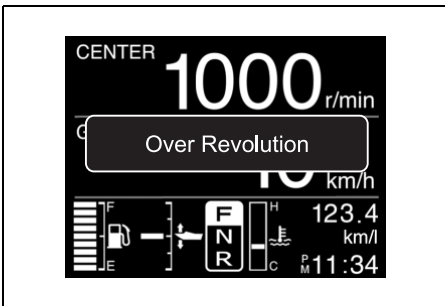

The “Over Revolution” indication clears when any of the button is pressed in the gauge.

This system must be reset by moving the throttle to the idle position for about one second to restore full engine operation.

**NOTICE**

If the Over-Revolution Caution System activates at recommended maximum throttle and you are sure that the propeller pitch is sufficient and there are no factors like “over-trimming” or “ventilation”, there may be a problem with the Over-Revolution Caution System.

Consult your authorized Suzuki marine dealer if the Over-Revolution Caution System activates for no apparent reason.

**OIL PRESSURE CAUTION SYSTEM**

This system operates when the engine lubricating oil pressure drops below the correct level.

If this system activates, the “Low Oil Pressure” and caution alarm icon are displayed on screen, and the buzzer sounds. In addition, when this system is activated at 1000 r/min. or higher, engine speed will automatically be reduced to approximately 1000 r/min.

If you continue to run, the engine will automatically stop 3 minutes after beginning of the above CAUTION system activation.

**NOTE:**

*In case that the engine is automatically stopped due to the CAUTION system, the engine can be started again.*

*However the CAUTION system will repeatedly activate until eliminating the cause.*

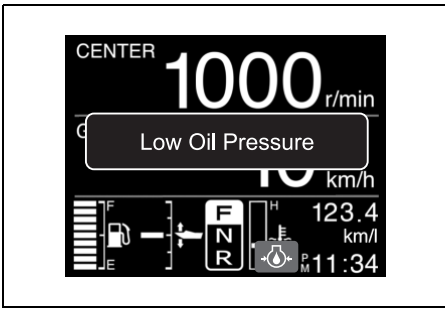

The “Low Oil Pressure” indication clears when any of the button is pressed in the gauge. However, the caution alarm icon is displayed until eliminating the cause.

If this system activates, stop the engine immediately, if wind and water conditions make it safe to do so.

Check the oil level and add oil if necessary. If the oil level is correct, consult your authorized Suzuki Marine Dealer.

**NOTICE**

Your engine may become severely damaged if you rely on the Oil Pressure Caution System to indicate the need to add engine oil.

Check the engine oil level periodically and add oil as necessary.

**NOTICE**

Operating the engine with the Oil Pressure Caution System activated can result in severe engine damage.

If the Oil Pressure Caution System activates, stop the engine as soon as possible and add engine oil, if necessary, or otherwise correct the problem.

**OVERHEAT CAUTION SYSTEM**

This system is activated when the cylinder wall temperature is too high due to insufficient water cooling.

**NOTE:**

The overheat caution system will not detect high combustion chamber temperature caused by, for example, an oil system malfunction, poor quality fuel, or spark plugs with an incorrect heat range.

If this system activates, the “Overheat” and caution alarm icon are displayed on screen, and the buzzer sounds. In addition, when this system is activated at 2000 r/min. or higher, engine speed will automatically be reduced to approximately 2000 r/min.

If you continue to run, the engine will automatically stop 3 minutes after beginning of the above CAUTION system activation.

**NOTE:**

In case that the engine is automatically stopped due to the CAUTION system, the engine can be started again.

However the CAUTION system will repeatedly activate until eliminating the cause.

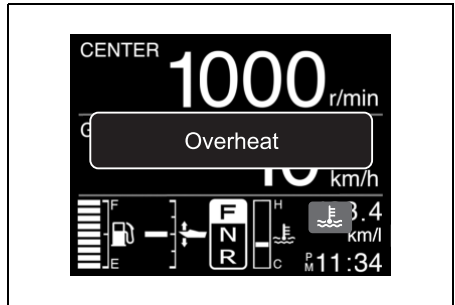

The “Overheat” indication clears when any of the button is pressed in the gauge. However, the caution alarm icon is displayed until eliminating the cause.

If the overheat caution system activates when operating, reduce engine speed immediately and check if water is being discharged from the pilot water hole. If no water is seen, follow the procedures outlined below.

Water and wind conditions permitting, stop the engine, tilt it out of the water and remove any debris like seaweed, plastic bags or sand that may have blocked the water intakes. Lower the engine into the water, being sure that water intakes are immersed, and restart it.

Check (A) that water discharges from the pilot hole and (B) that “Overheat” is not displayed on screen.

Be aware that “Overheat” is displayed on screen again if engine temperature rises abnormally. If either of the above situations arises, your authorized Suzuki Marine Dealer must be consulted as soon as possible.

**NOTE:**

*If pilot hole water discharge is sufficient, buzzer and display on screen may still operate until engine temperature decreases. Run engine in NEUTRAL only until the caution systems are cancelled.*

**NOTICE**

**Operating the engine with the Overheat Caution System activated can result in severe engine damage.**

**If the Overheat Caution System activates, stop the engine as soon as possible, wind and water conditions permitting, and inspect the engine according to the above instructions. Consult your authorized Suzuki marine dealer if you cannot correct the problem.**

**NOTE:**

*Remember that the overheat caution system cannot detect overheating caused by, for example, an oil system malfunction, poor quality fuel, or incorrect spark plugs.*

**NOTE:**

*If the engine is operated beyond the maximum trim position, the water intake holes may be above the water line. In this situation, the overheat caution system may activate.*

## CHECK THERMOSTAT ALERT SYSTEM

This ALERT SYSTEM activates when the thermostat breaks down and the engine temperature does not rise up to the proper temperature after engine start-up.

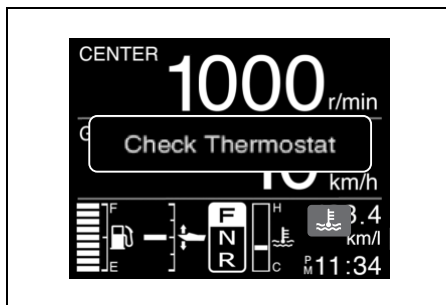

If this system activates, the “Check Thermostat” and caution alarm icon (the color of the icon is blue) are indicated on the screen.

The “Check Thermostat” indication clears when any of the button is pressed in the gauge. However, the caution alarm icon is displayed until the eliminating the cause.

In order to cancel this ALERT SYSTEM, quickly stop the engine and consult with SUZUKI marine dealer.

## BATTERY VOLTAGE CAUTION SYSTEM

This system is activated when the battery voltage deficiency which could impair your motor's performance occurs.

If this system activates, the "Low Battery Voltage" and caution alarm icon are indicated on screen and the buzzer sounds.

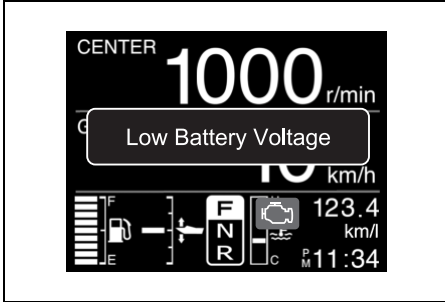

The "Low Battery Voltage" indication clears when any of the button is pressed in the gauge. However, the caution alarm icon is displayed until eliminating the cause.

This system will be canceled automatically when the battery voltage restores to the proper voltage level. Refrain from using any electrical equipment such as PTT system, hydraulic trim tabs, hydraulic jack plate, etc.

### **▲ WARNING**

**Failure to take proper precautions when inspecting or servicing the battery can be hazardous.**

**Do not attempt to inspect or service the battery without first reading the warnings, cautions, and instructions in the "BATTERY INSTALLATION" section of this manual.**

### **NOTE:**

- A marginal battery may have enough power to start your engine, yet may still cause this caution system to activate whenever engine or boat accessory use places a high current demand on the battery.
- If equipped with Keyless Start System: If a message "Low Battery Voltage" is displayed and the engine stops while the Keyless Start System is in ON state, check the following:

*If not equipped with Keyless Start System: If a message, "Low Battery Voltage" is displayed while the ignition key is in the "ON" position and the engine stops, check following:*

- The battery switch is in the "ON" position.
- The battery is connected correctly.
- The battery is in sound condition.
- If this caution system activates continuously, even after you have stopped using engine or boat accessories, contact your authorized Suzuki Marine Dealer.

# ELECTRONIC THROTTLE AND SHIFT CONTROL CAUTION SYSTEM

## CONTROL UNIT COMMUNICATION CAUTION SYSTEM

This system is activated in the event of an error in the control system of the electronic throttle and shift systems.

If this system activates, the “Check Control Unit C.” and caution alarm icon are displayed on screen, and the buzzer sounds.

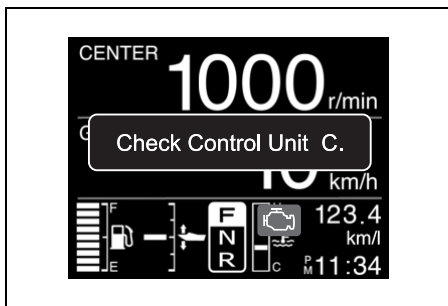

The “Check Control Unit C.” indication clears when any of the button is pressed in the gauge. However, the caution alarm icon is displayed until eliminating the cause.

### **NOTICE**

**If this system activates for no apparent reason, there may be a problem with the system.**

**Consult your authorized Suzuki marine dealer.**

## 2ND STATION CAUTION SYSTEM

This system is activated in the event of an error in the control system of the 2nd station.

If this system activates, the “Check 2nd Station” and caution alarm icon are displayed on screen, and the buzzer sounds. If this system is activated, the engine cannot be controlled any more from the 2nd station but can be controlled from the 1st station.

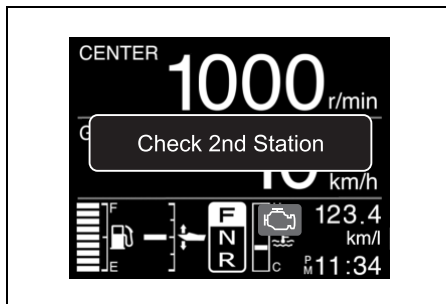

The “Check 2nd Station” indication clears when any of the button is pressed in the gauge. However, the caution alarm icon is displayed until eliminating the cause.

### **NOTICE**

**If this system activates for no apparent reason, there may be a problem with the system.**

**Consult your authorized Suzuki marine dealer.**

## THROTTLE SYSTEM CAUTION SYSTEM

This system is activated in the event of an error of the control system of the electronic throttle.

If this system activates, the “Check Throttle System” and caution alarm icon are displayed on screen, and the buzzer sounds. In addition, the engine highest rpm is restricted to 2000 r/min.

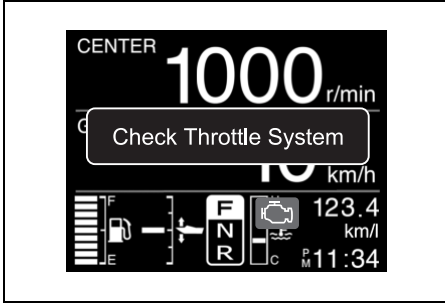

The “Check Throttle System” indication clears when any of the button is pressed in the gauge. However, the caution alarm icon is displayed until eliminating the cause.

### NOTICE

**If this system activates for no apparent reason, there may be a problem with the system.**

**Consult your authorized Suzuki marine dealer.**

## SHIFT CONTROL CAUTION SYSTEM

This system is activated in the event of an error of the control system of the electronic shift.

If this system activates, the “Check Shift Control” and caution alarm icon are displayed on screen and the buzzer sounds.

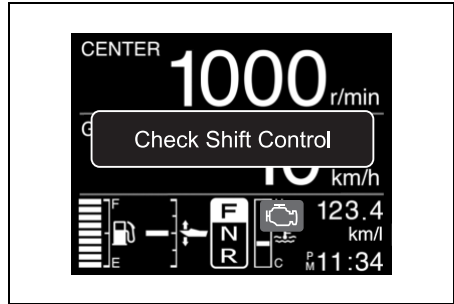

If this system is activated, the engine speed or shift cannot be controlled by operating the remote control lever but the engine can be operated at the idle speed.

By shifting the remote control lever to the neutral position and pressing the throttle only switch ①, the engine speed can be adjusted from the idle speed to approximately 2000 r/min. with the remote control lever.

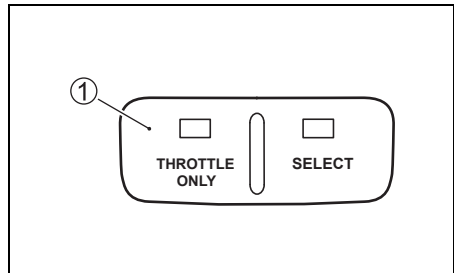

### NOTE:

*While the message, “Check Shift Control”, is displayed, the clutch cannot be shifted to the Forward, Neutral or Reverse position.*

The “Check Shift Control” indication clears when any of the button is pressed in the gauge. However, the caution alarm icon is displayed until eliminating the cause.



## NOTICE

If this system activates for no apparent reason, there may be a problem with the system.

Consult your authorized Suzuki marine dealer.

## GAUGE COMMUNICATION CAUTION SYSTEM

This system activates when there is a communication error of the gauge.

If this system activates, the “Check Gauge C.” is indicated on the screen.

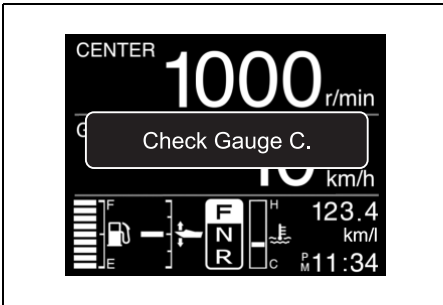

The “Check Gauge C.” indication clears when any of the buttons are pressed on the gauge.

## NOTICE

If this system activates for no apparent reason, there may be a problem with the system.

Consult your authorized Suzuki marine dealer.

## STATION SETTING TROLL MODE CAUTION SYSTEM

This system is activated when the TROLL mode operation is started on the gauge screen of the cockpit, where the TROLL Mode operation is not available.

If this system activates, the “Check Station Setting” is displayed on screen.

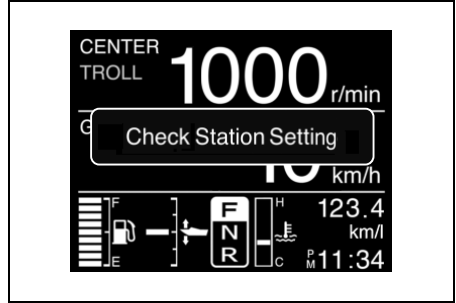

Identify the cockpit where the SELECT LED ① on the remote control box is turned ON and perform the TROLL Mode operation from the gauge screen of that cockpit where the SELECT LED is turned ON.

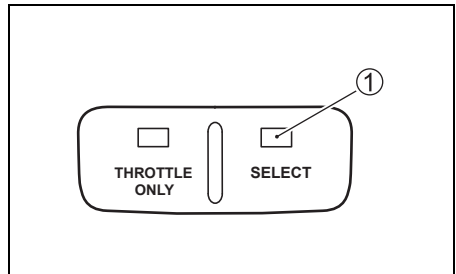

On the gauge screen where the TROLL Mode operation is available, **TROLL** is displayed.

The “Check Station Setting” indication clears when any of the button is pressed in the gauge.

## TROLL CONDITION CAUTION SYSTEM

This system activates when the mode cannot be transferred to the TROLL Mode.

If this system activates, the “Check Troll Condition” is displayed on screen.

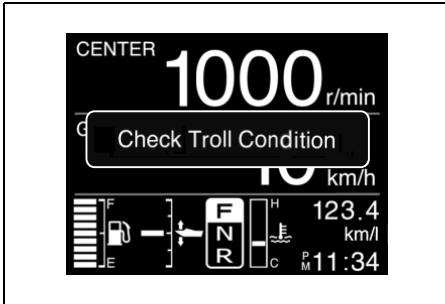

Make sure that the remote control lever has been shifted into forward or reverse and the engine throttle has been fully closed. Refer to the Setting the Troll Mode section.

The “Check Troll Condition” indication clears when any of the button is pressed in the gauge.

## TROLL SYSTEM CAUTION SYSTEM

The current ECM and BCM of your outboard motor does not applicable to the troll mode system.

If this system activates, the “Check Troll System” is displayed on screen.

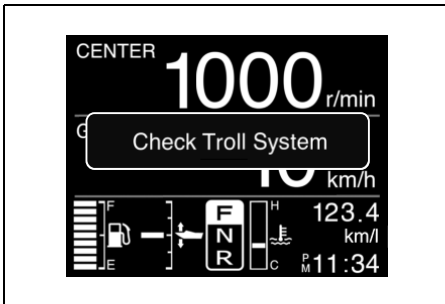

The “Check Troll System” indication clears when any of the button is pressed in the gauge. If this system activates, consult your authorized Suzuki Maine Dealer.

## KEYLESS START SYSTEM CAUTION SYSTEM

(IF EQUIPPED WITH KEYLESS START SYSTEM)

### KEYLESS FOB CAUTION SYSTEM

The caution system is activated when keyless fob identification error.

If this system activates, the “Check Keyless FOB” and caution alarm icon are indicated on the screen.

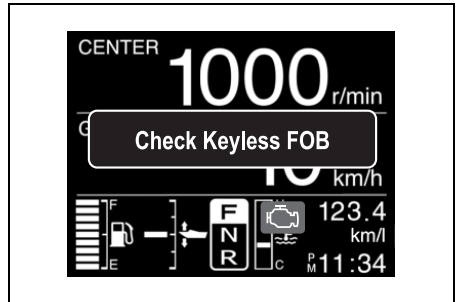

The “Check Keyless FOB” is cleared when any of the buttons are pressed on the gauge. However, the caution alarm icon is displayed until the cause is addressed.

#### NOTE:

- If the message “Check Keyless FOB” is displayed, check the following:
  - The keyless fob is within the communication range of the keyless control unit.
  - The keyless fob is in communication mode. (Refer to “Switching the communication mode of the keyless fob” section.)
  - There is no object interfering with the radio wave between the keyless fob and the keyless control unit.
  - The keyless fob battery has sufficient capacity.
  - The correct keyless fob has been authenticated by the Keyless Start System.
- If this caution system activates continuously, contact your authorized Suzuki Maine Dealer.

## KEYLESS FOB BATTERY CAUTION SYSTEM

The caution system is activated when keyless fob battery voltage drops to a point which could impair keyless fob performance.

If this system activates, the “Keyless FOB Battery Low” and caution alarm icon are indicated on the screen.

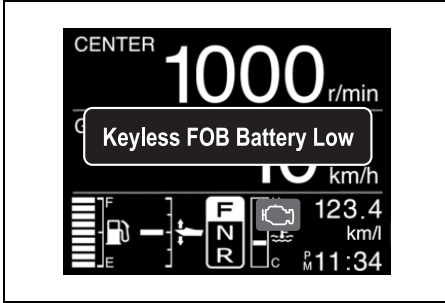

The “Keyless FOB Battery Low” is cleared when any of the buttons are pressed on the gauge. However, the caution alarm icon is displayed until the cause is addressed.

### NOTE:

If this system activates, replace the battery of keyless fob. (Refer to **KEYLESS FOB BATTERY REPLACEMENT** section.)

## KEYLESS CONTROL UNIT CAUTION SYSTEM

This system is activated when the 12 volt battery voltage to the keyless control unit drops to a point which could impair the keyless control unit performance.

If this system activates, the “Keyless Unit Battery Low” and caution alarm icon are indicated on the screen.

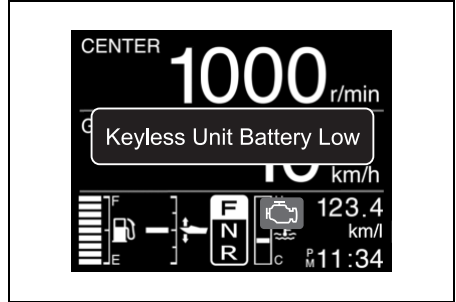

The “Keyless Unit Battery Low” is cleared when any of the buttons are pressed on the gauge. However, the caution alarm icon is displayed until the cause is addressed.

### NOTE:

- If the message “Keyless Unit Battery Low” is displayed, check the following:
  - The 12 volt battery is in sound condition.
  - Contact failure of the battery terminal.
- If this caution system activates continuously, consult your authorized Suzuki Maine Dealer.

# DIAGNOSTIC SYSTEM

If abnormal conditions exist in any sensor signal being input to the control unit, the self-diagnostic system warns of the abnormal condition.

If this system activates, the “Check Engine X – X” and check engine icon are displayed on screen, and the buzzer sounds.

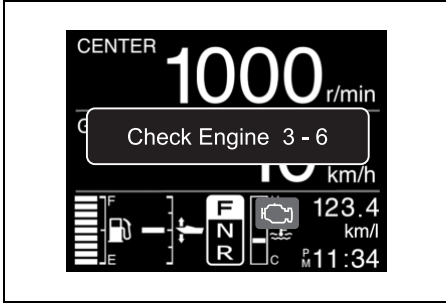

The “Check Engine X – X” is cleared when any of the buttons are pressed in the gauge. However, the check engine icon is displayed until the cause is addressed.

Also incorporated is a fail-safe provision that allows the operation at a restricted speed even under such a failure condition.

**NOTE:**

- If equipped with Keyless Start System:  
This diagnostic code is designed to appear while the Keyless Start System is in ON state.

*If not equipped with Keyless Start System:*

*This diagnostic code is designed to appear while the ignition key is turned on.*

- The buzzer sound with diagnostic system activating will be canceled by pushing the ignition key in.

## NOTICE

If the diagnostic system activates while you are operating your outboard motor, there is an abnormal condition in one of the sensor signals of the control system.

Consult your authorized Suzuki marine dealer for repair of the control system.

# OIL CHANGE REMINDER SYSTEM

This system informs the operator of the time for replacing engine oil on the basis of the maintenance schedule.

The system is designed to register the total operating hours of the outboard motor and function its operation when the preprogrammed hours have reached.

(Refer to the INSPECTION AND MAINTENANCE section and the last page.)

## SYSTEM ACTIVATION

When the total operating hours have reached the preprogrammed hours, the “Change Oil” is displayed on screen, and the buzzer sounds. This indication will repeat until you cancel the system activation.

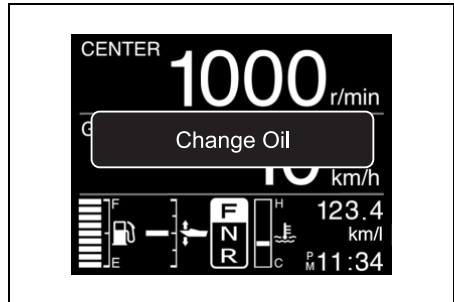

## CANCELLATION

For the single engine:

1. If equipped with Keyless Start System:  
Press and hold the engine switch ① for more than two seconds to turn on the power.

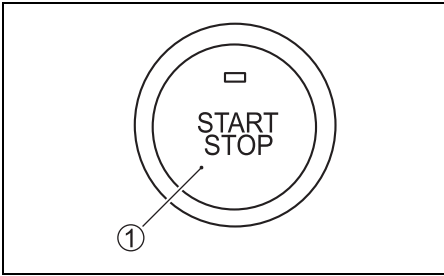

If not equipped with Keyless Start System:  
Turn the ignition key to the "ON" position.

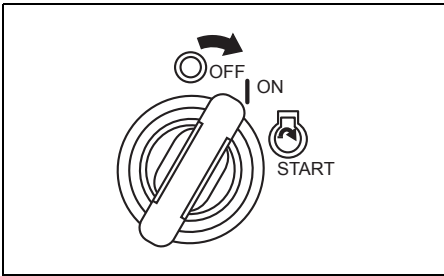

2. Pull out the emergency stop switch lock plate ②.
3. Pull up the emergency stop switch knob ③ three times within 10 seconds. A short beep will be heard if the cancellation is successfully finished.

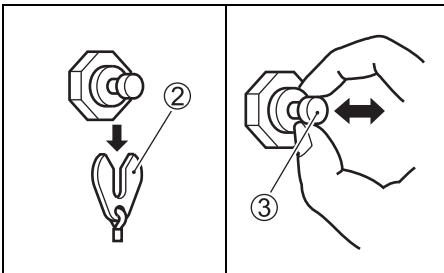

4. If equipped with Keyless Start System:  
Press and hold the engine switch ① for more than two seconds to turn off the power.

**NOTE:**

*The power can also be turned off by pressing the lock button on the keyless fob.*

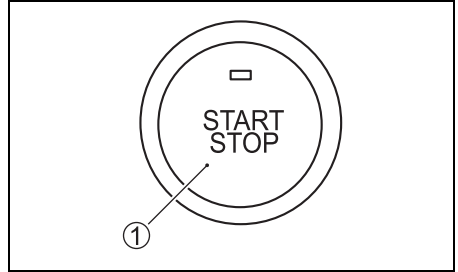

If not equipped with Keyless Start System:  
Turn the ignition key to the "OFF" position.

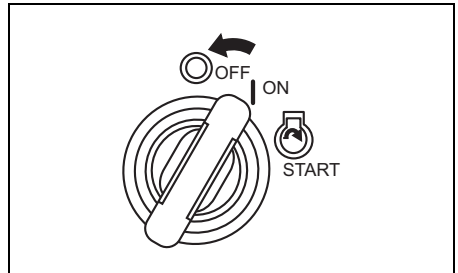

5. Set the plate ② in the original position.

For the multiple engines:

1. If equipped with Keyless Start System:  
Press and hold the engine switch ① for more than two seconds to turn on the power.

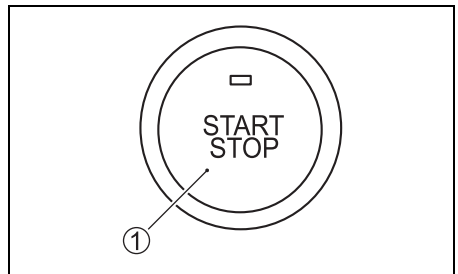

If not equipped with Keyless Start System:  
Turn the ignition key to the "ON" position.

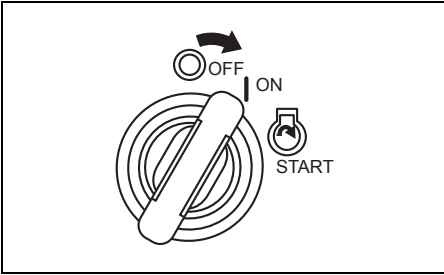

If not equipped with Keyless Start System:  
Turn the ignition key to the "OFF" position.

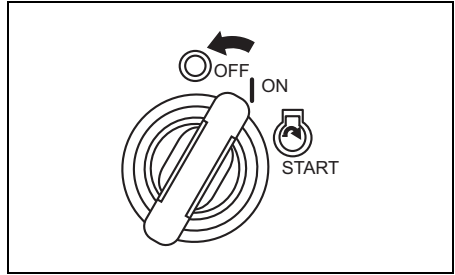

2. Pull out the emergency stop switch lock plate ②.
3. Push the start & stop switch ③ three times in 10 seconds. A short beep will be heard if the cancellation is successfully finished.

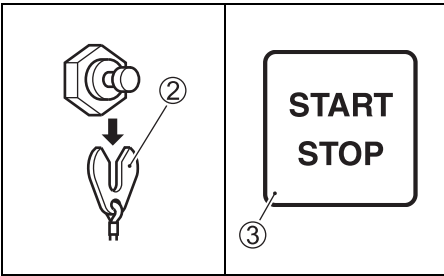

4. If equipped with Keyless Start System:  
Press and hold the engine switch ① for more than two seconds to turn off the power.

**NOTE:**

The power can also be turned off by pressing the lock button on the keyless fob.

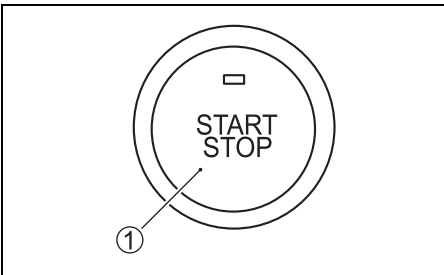

5. Set the plate ② in the original position.

**NOTE:**

- Canceling of the system activation is possible regardless of whether or not the engine oil has been replaced. Once the system has operated, however, Suzuki strongly recommends that the engine oil be replaced before canceling the system activation.
- Even if the engine oil has been replaced with the system not operating, it is still necessary to perform the cancellation.

# ENGINE STALLING CAUTION SYSTEM

This system informs the operator when the motor stalls while it is operating. When the engine stalls for any reason, the caution buzzer sounds three times.

# WATER IN FUEL ALERT SYSTEM

This engine is equipped with an integral fuel filter/water separator and associated alert system.

The alert system will activate if water separated from the fuel exceeds a specific volume.

If this system activates, the “Water in Fuel” and caution alarm icon will display at all the time and a buzzer will sound when the engine is in neutral only.

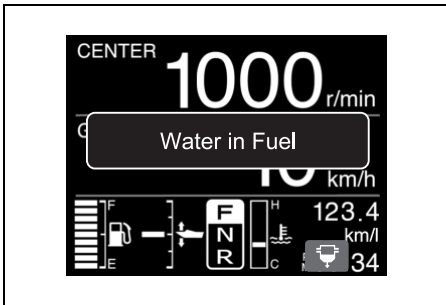

The “Water in Fuel” indication clears when any of the button is pressed in the gauge. However, the caution alarm icon is displayed until the eliminating the cause.

If this system activates, stop the engine immediately, if wind and water conditions are safe to do so, and check the fuel filter/water separator for water. Or consult your authorized Suzuki marine dealer.

For inspection and cleaning of the fuel filter, refer to the LOW PRESSURE FUEL FILTER in the INSPECTION AND MAINTENANCE section.

# OPERATION OF TILTING SYSTEMS

## POWER TRIM AND TILT

The “Power Trim and Tilt” is operated by pressing the switch. To tilt the motor up, press the upper part of the switch. To tilt the motor down, press the lower part of the switch.

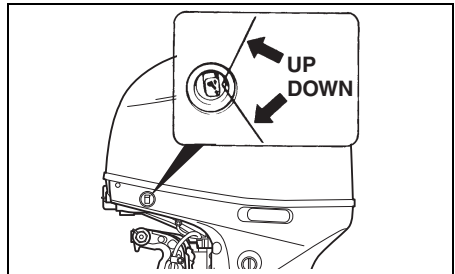
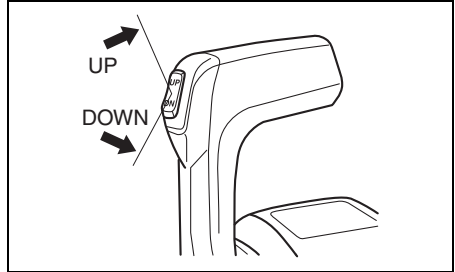

If equipped with Keyless Start System:

**⚠ WARNING**

The power trim and tilt (PTT) switch on the side cover can be accidentally activated when the Keyless Start System is in OFF state, resulting in injury.

Keep all persons away from the outboard motor to help prevent accidental activation of the PTT system.

If not equipped with Keyless Start System:

### **▲ WARNING**

The power trim and tilt (PTT) switch on the side cover can be accidentally activated when the ignition key is off, resulting in injury.

Keep all persons away from the outboard motor to help prevent accidental activation of the PTT system.

#### **NOTE:**

*If equipped with Keyless Start System:  
The PTT switch on the remote control lever cannot be activated when the keyless start system is in OFF state.*

*If not equipped with Keyless Start System:  
The PTT switch on the remote control lever can not be activated when the ignition key is off.*

#### **NOTE:**

*Repeated operation of the power trim and tilt (PTT) causes the overheating of the PTT motor and the protection circuit may stop the operation of the motor. While the protection circuit activated, the PTT switch is inoperative. This inoperative condition of the system is cancelled once the overheating is resolved.*

## **MANUAL TILTING**

If you are unable to tilt the motor using the "Power Trim and Tilt" because of an electrical problem or some other problem, you can move the motor manually. To tilt the motor up or down, turn the manual release valve (A) two turns counterclockwise, move the motor to the desired position, then retighten the release screw.

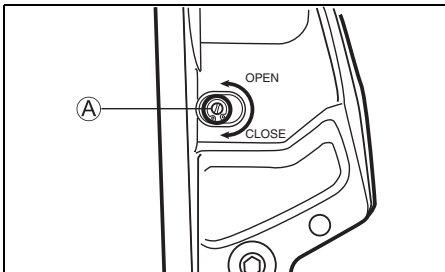

### **▲ CAUTION**

The motor is very heavy. When you tilt it manually, you could injure your back or slip and fall causing injury.

When you tilt the motor manually, ensure that your grip and footing are secure and that you are able to support the weight of the engine.

## **TILT LOCK LEVER**

The Tilt Lock Lever is provided so you can support the motor in a tilted position for non-moving engine support.

To set the Tilt Lock Lever:

1. Tilt the motor all the way up by pressing the Power Trim and Tilt "UP" switch.
2. Pull down the Tilt Lock Lever as shown in the illustration.
3. Lower the motor by pressing the Power Trim and Tilt "DOWN" switch, until the motor is supported by the Tilt Lock Lever.

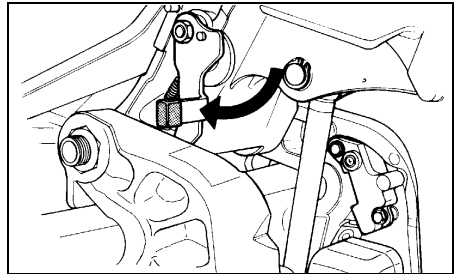

4. For DF140BG:  
Continue to operate the Power Trim and Tilt "DOWN" switch until the trim rods are completely retracted.

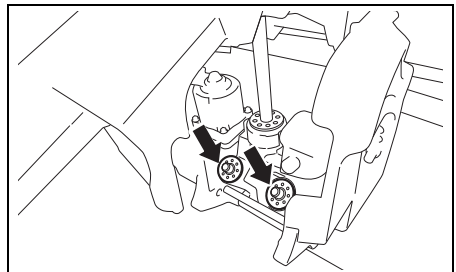



**NOTICE**

If you do not retract the trim rams completely when mooring, they may become deteriorated or corroded.

Be sure to retract the trim rams completely when mooring.

To release the Tilt Lock Lever, tilt the motor all the way up using the Power Trim and Tilt "UP" switch, and pull up the Tilt Lock Lever.

If equipped with Keyless Start System:

**▲ CAUTION**

The remote Power Trim and Tilt switch will work when the Keyless start system is off. If someone activates the switch while you are moving the tilt lock lever, your hand could be injured.

Keep all persons away from the remote Power Trim and Tilt switch while you are moving the tilt lock lever.

**NOTICE**

Damage can occur if you use the tilt lock lever other than when the boat is moored or is otherwise stationary.

The tilt lock lever relieves pressure from the power trim and tilt and should only be used when the boat is stationary. Do not use the tilt lock lever when trailering your boat and motor. Refer to the TRAILERING section of this manual.

If not equipped with Keyless Start System:

**▲ CAUTION**

The remote Power Trim and Tilt switch will work when the ignition key is off. If someone activates the switch while you are moving the tilt lock lever, your hand could be injured.

Keep all persons away from the remote Power Trim and Tilt switch while you are moving the tilt lock lever.

**NOTICE**

Damage can occur if you use the tilt lock lever other than when the boat is moored or is otherwise stationary.

The tilt lock lever relieves pressure from the power trim and tilt and should only be used when the boat is stationary. Do not use the tilt lock lever when trailering your boat and motor. Refer to the TRAILERING section of this manual.

# INSPECTION BEFORE BOATING

## ▲ WARNING

Failure to inspect your boat and motor before beginning a trip can be hazardous.

Before boating, always perform the inspections described in this section.

It is important to make sure that your boat and motor are in good condition and that you are properly prepared for an emergency. Always perform the following checks before you begin boating:

- Make sure that you have enough fuel for the intended run.
- Check the level of engine oil in the sump.

## NOTICE

Running the engine with an insufficient amount of oil can cause serious engine damage.

Always check the oil level before each trip and add oil if necessary.

To check the oil level:

### NOTE:

To avoid an incorrect assessment of engine oil level, check the level only when the engine has cooled.

1. Place the motor in a vertical position, then remove the motor cover ① by unlocking the lever ② and ③.

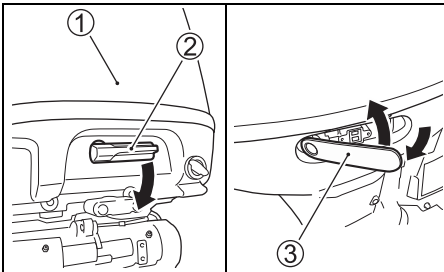

2. Pull out the oil dipstick and wipe oil off with a clean cloth.

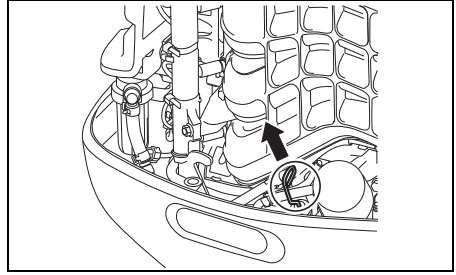

### NOTE:

If the engine oil is contaminated or discolored, replace with fresh engine oil (Refer to Inspection and maintenance/engine oil section).

3. Insert the dipstick all the way into the engine, then remove it again.

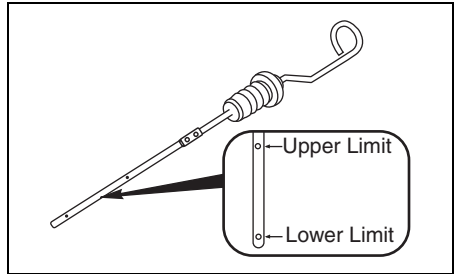

The oil on the dipstick should be between the upper and lower limits shown on the dipstick. If the oil level indication is near the lower limit, add enough oil to raise the level to the upper limit.

To fill the engine oil:

1. Remove the oil filler cap.
2. Fill the recommended engine oil to the upper level.

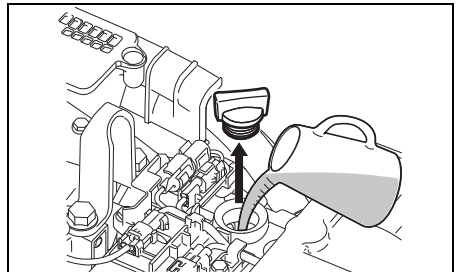

### **NOTICE**

Running the engine with an excessive amount of oil can damage the engine.

Do not overfill the engine with oil.

3. Tighten the oil filler cap securely.
  - **Check the battery solution level.**  
The level should be kept between the MAX and the MIN level lines at all times. If the level drops below the MIN level line, refer to MAINTENANCE section.
  - **Make sure that the battery leads are securely connected to the battery terminals.**
  - **Visually check the propeller to make sure it is not damaged.**
  - **Make sure that the motor is securely mounted to the transom.**
  - **Check for proper operation of the Power Trim and Tilt.**
  - **Make sure that the tilt pin is securely installed in the proper position.**
  - **Make sure you have the boating safety and emergency equipment on board.**
  - **Make sure that the emergency stop switch operates properly.**
  - **Make sure the obstacle is not attached to water intake hole.**

## **BREAK-IN**

Proper operation during this break-in period will help ensure maximum life and performance from your engine. The following guidelines will explain proper break-in procedures.

### **NOTICE**

Failure to follow the break-in procedures described below can result in severe engine damage.

Be sure to follow the engine break-in procedures described below.

**Break-in period:** 10 hours

#### **Break-in procedure**

1. For the initial 2 hours:  
Allow sufficient idling time (about 5 minutes) for the engine to warm up after cold engine starting.

### **NOTICE**

Running at high speed without sufficient warm-up may cause severe engine damage such as piston seizure.

Always allow sufficient idling time (5 minutes) for the engine to warm-up before running at high speed.

After warming up, run the engine at idling speed or the lowest in-gear speed for about 15 minutes.

During the remaining 1 hour and 45 minutes, if safe boating conditions permit, operate the engine in gear at less than 1/2 (half) throttle (3000 r/min.).

**NOTE:**

You may throttle up beyond the recommended operating range to plane your boat, then immediately reduce the throttle to the recommended operating range.

- For the next 1 hour:  
Safe boating conditions permitting, operate the engine in gear at 4000 r/min. or at three-quarter throttle. Avoid running the engine at full throttle.
- Remaining 7 hours:  
Safe boating conditions permitting, operate the engine in gear at desired engine speed. You may occasionally use full throttle; however do not operate the engine continuously at full throttle for more than 5 minutes at any time.

**NOTICE**

Running continuously at full throttle for more than 5 minutes at a time during the last 7 hours of break-in operation may cause severe engine damage such as seizure.

During the last 7 hours of break-in operation, do not operate at wide open throttle for more than 5 minutes at a time.

# OPERATION

## ENGINE SWITCH (OPTION)

Use this switch if equipped with Keyless Start System.

- Quickly press the engine switch to start and stop all engines. (The buzzer sounds once.)
- Press and hold the engine switch for at least 2 seconds to set the Keyless Start System ON state and OFF state. (The buzzer sounds once.)

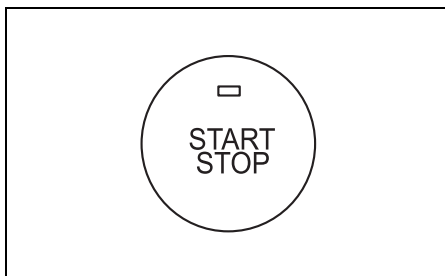

## IGNITION SWITCH (OPTION)

Use this switch if not equipped with Keyless Start System.

- Turn until the ignition key is in the "ON" position.
- Turning the ignition key to the "START" position automatically starts all engines.

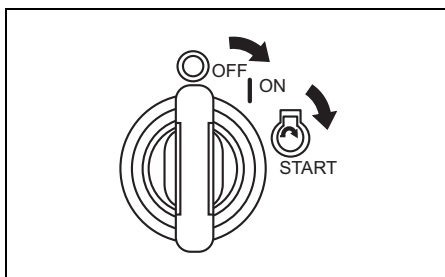

# CONTROL PANEL (OPTION)

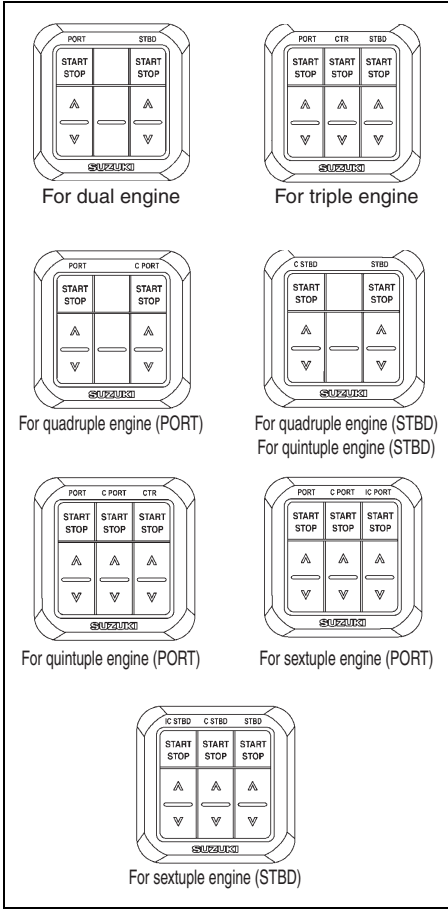

**NOTE:**

- On a boat equipped with quadruple engines, use control panel for quadruple engine (PORT) and control panel for quadruple engine (STBD).
- On a boat equipped with quintuple engines, use control panel for quintuple engine (PORT) and control panel for quintuple engine (STBD).
- On a boat equipped with sextuple engines, use control panel for sextuple engine (PORT) and control panel for sextuple engine (STBD).

## Start & Stop Switch

This is a switch to start and stop the engine. The engine can be started with the remote control handle at the neutral position.

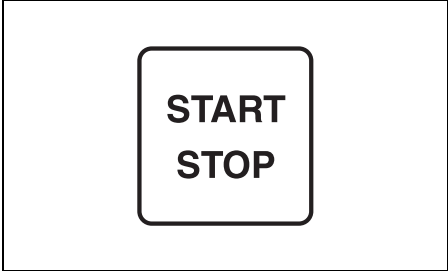

### [^] (UP) & [v] (DOWN)

The "Power Trim and Tilt" is operated by pressing the switch. To tilt the motor up, press the [^] switch. To tilt the motor down, press the [v] switch.

**NOTE:**

The tilt up and tilt down switches cannot be activated when the power off.

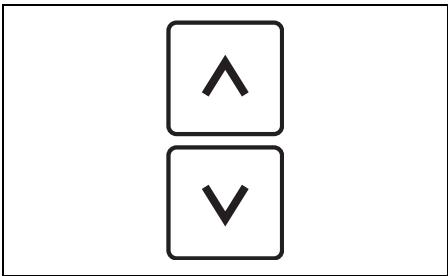

## REMOTE CONTROL BOX

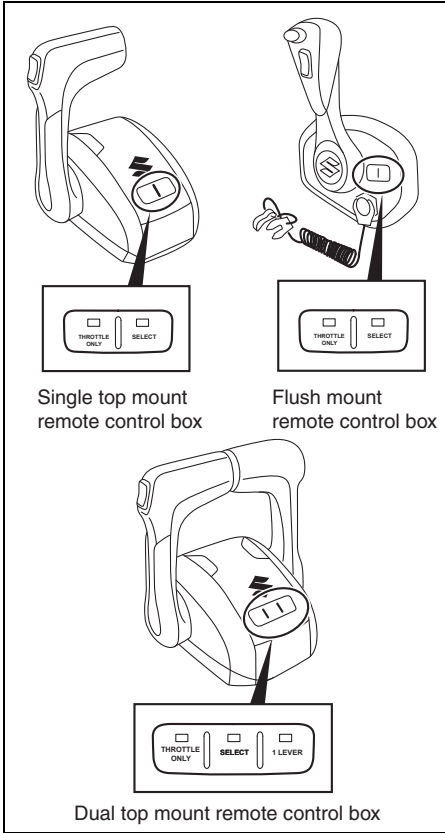

### Throttle Only Switch

This switch holds the shift position in neutral, thereby allowing operation the throttle without changing the shift position. When the shift position is hold in neutral, the THROTTLE ONLY LED comes on and when the switch is released, the THROTTLE ONLY LED goes out. The throttle only switch is only enabled when the remote control handle is in the neutral position.

#### NOTE:

*If this switch is operated with the remote control handle in a position other than neutral, the THROTTLE ONLY LED blinks and a buzzer sounds at the same time.*

#### NOTE:

- When selecting the THROTTLE ONLY mode, continue to push the THROTTLE ONLY switch until the buzzer sounds one short beep.
- If the THROTTLE ONLY mode cannot be selected, turn off the power and wait for 20 seconds, and then turn on the power again.
- Consult your authorized Suzuki marine dealer if the THROTTLE ONLY mode can not be selected.

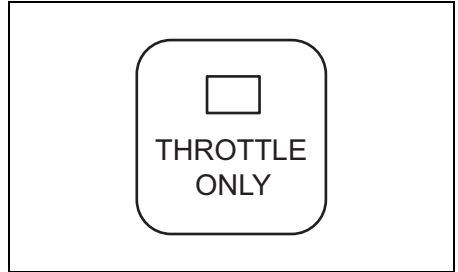

### Station Select Switch

This switch control between driving stations on boats equipped with more than one driving station.

When pushing the select switch to select station, SELECT LED at the driving station selected comes on, and the SELECT LED at the driving station not selected goes out.

This switch is enabled only when the remote control handle at the 1st and 2nd driving stations are at the neutral position.

#### NOTE:

- When turn on the power, the 1st driving station is automatically selected.
- By operating this switch with the remote control handle in positions other than the neutral, the SELECT LED blinks and the buzzer sounds at the same time.

**NOTE:**

- When pushing the **SELECT** switch to select station, continue to push **SELECT** switch until the buzzer sounds one short beep.
- If failed to switch from the 2nd station to the 1st station, turn off the power and wait for 20 seconds, and then turn on the power again.
- Consult your authorized Suzuki marine dealer if the station can not be selected.

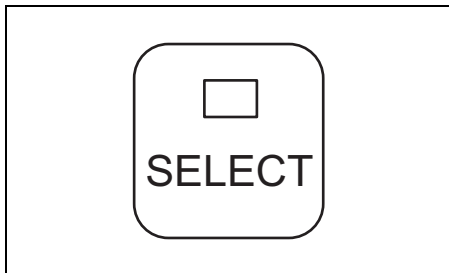

**1 Lever Switch (Dual top mount remote control box only)**

This switch allows to control all engines with the PORT side handle.

When all engines can be controlled by PORT side handle, the 1 LEVER LED comes on. When PORT engine group and STBD engine group can be controlled by each handle, the 1 LEVER LED goes out.

The 1 LEVER switch is only enabled when the all remote control handle is in the neutral position.

**NOTE:**

- When turn on the power, 1 lever control mode is automatically canceled.
- By operating this switch with the remote control handle in positions other than the neutral, the buzzer sounds.

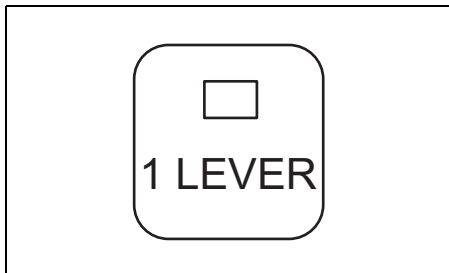

**BEFORE ATTEMPTING TO START THE ENGINE**

1. The motor has been lowered into the water.
2. The fuel hose is securely connected to the fuel tank and the motor.

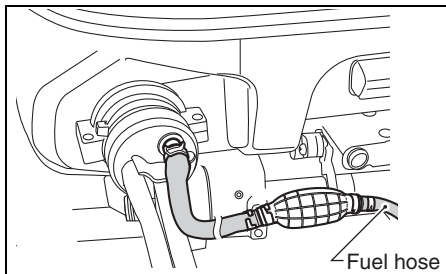

3. Direct the pilot water hole to the position you intend.

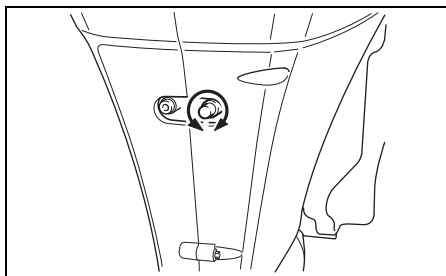

4. Ensure that the boat fuel tank is correctly vented and that any in-line filters are free of dirt etc. If fuel tank filler cap has a manual vent, be sure that it is fully open.

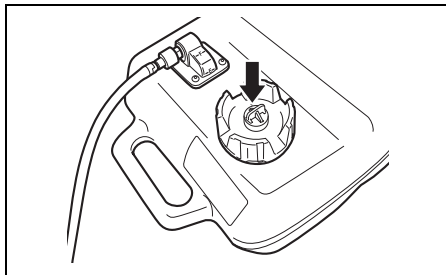

5. Make sure that the motor is in "NEUTRAL".

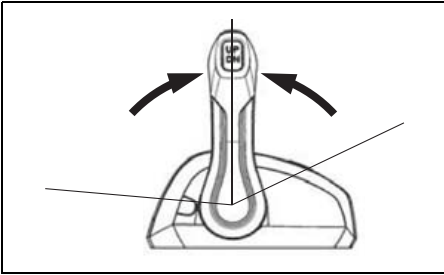

6. Make sure the lock plate is in place and attach the emergency stop switch cord to a part of your body.

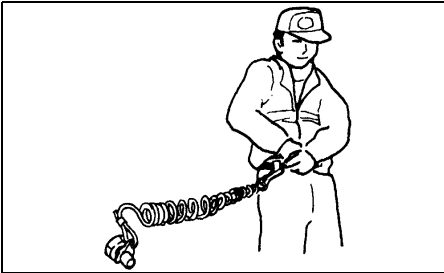
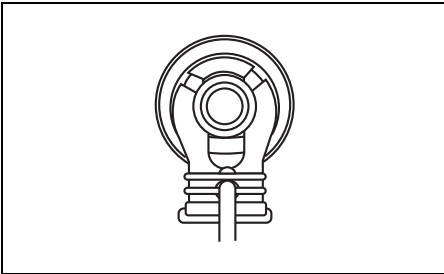

## **▲ WARNING**

Failure to properly attach the emergency stop switch cord or to take proper precautions to help ensure that the emergency stop switch works as intended may result in serious injury or death to the operator or passengers.

Always take the following precautions:

- Make sure that the emergency stop switch cord is fastened securely to the operator's wrist or to an appropriate clothing area (belt etc.).
- Ensure that no obstructions impede or restrict emergency stop switch operation.
- Be careful not to pull the stop switch cord or knock out the lock plate during normal operation. The motor will stop abruptly, and the loss of forward motion may unexpectedly throw occupants forward.

### **NOTE:**

*A spare plastic lock plate is provided for temporary use only. Remove it from the cord and place it in a safe place on board your boat. If you lose or break the emergency stop switch cord/lock plate assembly, replace it as soon as possible so that you can resume normal use of the emergency stop switch.*



## STARTING THE ENGINE

### **⚠ WARNING**

Exhaust gas contains carbon monoxide, a dangerous gas that is difficult to detect because it is colorless and odorless. Breathing carbon monoxide can cause death or severe injury.

Never start the engine or let it run indoors or where there is little or no ventilation.

#### NOTE:

If the emergency stop switch lock plate is not in position, the starter motor cannot operate.

1. Squeeze the fuel line priming bulb several times until you feel resistance.

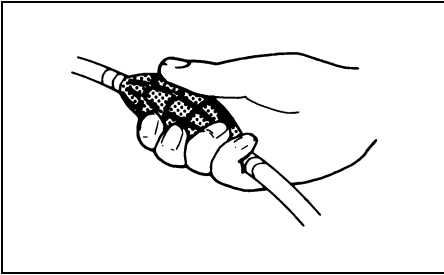

2. If equipped with Keyless Start System:

- (1) Confirm that the keyless fob is in communication ON mode (Refer to the "Switching the Communication mode of the keyless fob" section.) Check that the keyless fob is within communication range with the keyless control unit.
- (2) Quickly press the engine switch to set Keyless Start System to ON state (buzzer sounds once) and automatically start all engines.

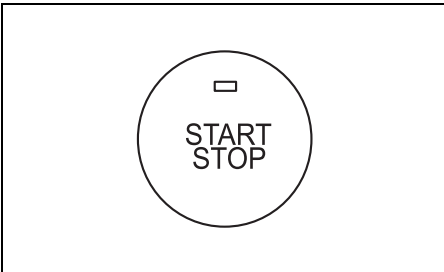

- (3) To start each engine individually, press and hold the engine switch for at least 2 seconds to set Keyless Start System to ON state (buzzer sounds once). Then press the control panel start/stop switch to start each engine individually.

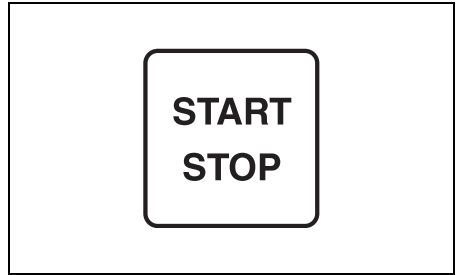

If not equipped with Keyless Start System:  
Turn until the ignition key is in the "ON" position.

Turning the ignition key to the "START" position automatically starts all engine.

After returning the ignition key to "ON" position from "START" one, starter motor continue to turn for 4 seconds until engine start.

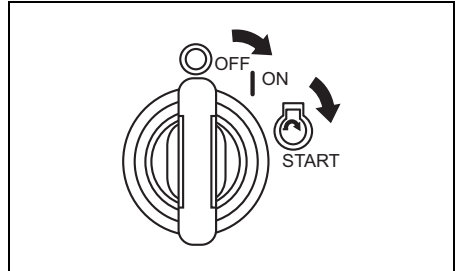

### **NOTICE**

If you hold the ignition key at the "START" position to start the engine, the starter system can be damaged.

Turn the ignition key to the "START" position once and release it to start the engine. The engine will crank continuously for 4 seconds or until the engine starts.

To start each engine individually, turn the ignition switch to the “ON” position. Then press the control panel start/stop switch to start each engine individually.

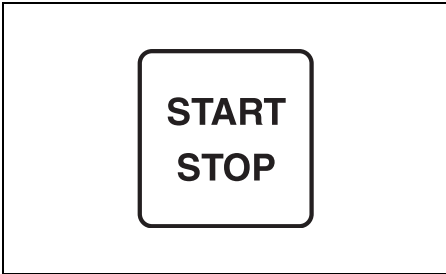
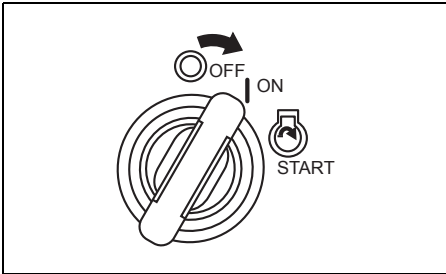

**NOTE:**

*If equipped with Keyless Start System:  
The communication range is a distance of 1 m (40 in) between the keyless fob and the keyless control unit.*

*If the Keyless Start System fails to turn ON, the buzzer emits one (1) long sound and three (3) short sounds.*

*In this case, repeat the procedure again.*

<b>NOTICE</b>
<p>If “Low Oil Pressure” is displayed on the screen of the meter while operating the outboard, the oil level may be low enough to damage the engine.</p> <p><b>Stop the engine and check the oil level.</b></p>

**NOTE:**

*The continuous operating time of the starter motor is set at four seconds.*

*When this time is exceeded, the starter motor will automatically stop.*

*If the motor stops, wait about ten seconds for the motor to cool down and try again.*

4. Warm up the engine for about 5 minutes.

<b>NOTICE</b>
<p><b>Operating the engine at high RPM or “wide open throttle” immediately after starting the engine without allowing the engine to warm up may cause engine failure.</b></p> <p><b>Always allow the engine to warm up sufficiently before operating it at high speeds.</b></p>

**Cooling water check**

As soon as the engine starts, water should spray out of the pilot water hole ①, indicating that the water pump and cooling system are working properly. If you notice that water does not spray out of the pilot water hole, stop the engine as soon as possible and consult your authorized Suzuki Marine Dealer.

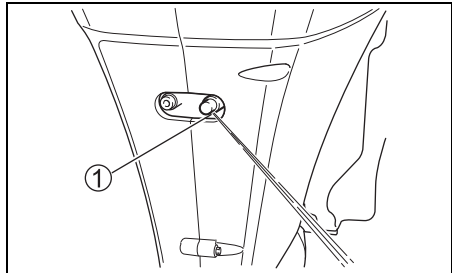

<b>NOTICE</b>
<p><b>Never operate your outboard motor when there is no water coming out of the pilot water hole, or severe damage can result.</b></p> <p><b>After starting the engine, check to make sure that there is water coming out of the pilot water hole.</b></p>

<b>▲ WARNING</b>
<p><b>Operating the boat when the emergency stop switch is not operating properly can be hazardous.</b></p> <p><b>Before starting off, check to make sure that the emergency stop switch operates properly.</b></p>

**If equipped with Keyless Start System:**

**EMERGENCY START**

If the keyless fob cannot be used due to a dead keyless fob battery or other issue, you can start the engines without the keyless fob by entering the passcode in the multi-function gauge.

Use the following procedure to start engines without using keyless fob.

1. Pressing engine switch causes “Check Keyless FOB” to appear on the screen. The buzzer will be triggered with one long beep followed by 3 short beeps.



2. “Enter Passcode?” appears when any button in the gauge is pressed. To enter the passcode, use the [▼] or [▲] button and then select “Yes”. Then, press the [SET] button to proceed to the “Enter Passcode” entry screen. (Selecting “NO” turns the system off.)

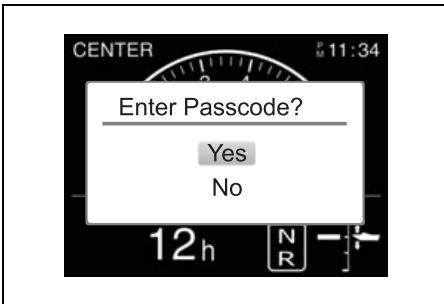

3. Enter a 6-digit passcode. Use the [▼] or [▲] buttons to select a number for each digit. Press the [SET] button to move to the next digit. Press the [MENU] button to return to the previous digit.

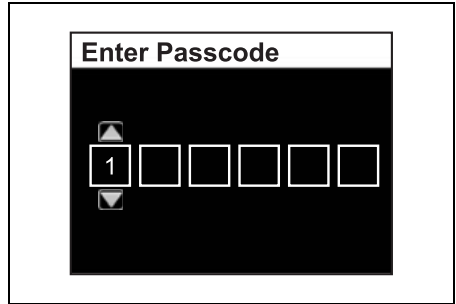

4. If the entered digits matches the 6-digit passcode, pressing the [SET] button will display the normal screen appears and starts the engines. The system returns to the screen from step 2 if the entered digits do not match the passcode. (Enter the passcode correctly.)



**NOTE:**

- If you select yes for [Enter Passcode?], you must complete the entry within 5 minutes. After 5 minutes, the power turns off.
- If the collation is NG, the "Enter Passcode?" screen reappears.
- If you enter the wrong passcode 5 times in a row, the keyless start system automatically powers down the keyless start system and does not accept a passcode for 30 seconds.

## To start the engine:

5. Make sure the motor is in “NEUTRAL”.

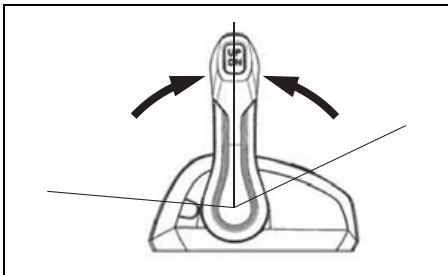

6. Make sure the lock plate is in place and the emergency stop switch cord is fastened securely to your wrist or appropriate clothing area such as your belt.

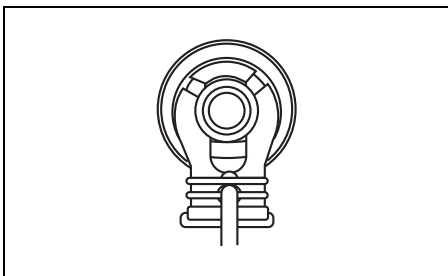

7. Quickly press the engine switch to turn the starter motor and start all engines.

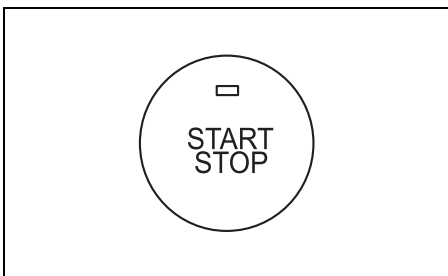

## SHIFTING AND SPEED CONTROL

### NOTICE

- Severe engine damage may occur if (a) engine speed is not allowed to return to idle and boat speed is not reduced when shifting from “FORWARD” to “REVERSE” or from “REVERSE” to “FORWARD”, or (b) care is not taken when operating the boat in reverse.
- Always allow the engine speed to return to idle before shifting. Exercise caution and use minimal speed when operating the boat in reverse. Be sure the handle/shift lever is in the desired position before accelerating.

### NOTE:

- On a boat equipped with triple engines, the center engine and port engine are started with port shift lever ① to link the center engine with the port engine.
- On a boat equipped with quadruple engines, the two engines on port side are started with shift lever ① and the two engines on starboard side are started with shift lever ②.
- On a boat equipped with quintuple engines, the center engine, port center engine and port engine are started with port shift lever ① to link the center engine with the two engines on port side and the two engines on starboard side are started with shift lever ②.
- On a boat equipped with sextuple engines, the three engines on port side are started with shift lever ① and the three engines on starboard side are started with shift lever ②.

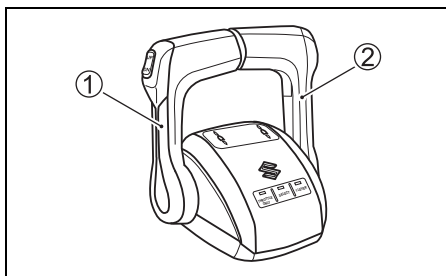

**NOTE:**

- When the engine stops, the clutch moves to the neutral position irrespective of the position of the remote control lever.
- The clutch cannot be changed over either to Forward or Reverse by operating the remote control lever while the engine stops.
- If gear shifting is attempted while the engine speed is high, the buzzer sounds twice and the shift position indicator light "N" displayed on the multi-function gauge, blinks. If this system activates, move the shift lever in to the full closed position.



**Shifting**

**NOTE:**

**Type B remote control box**

The type B remote control box has a lock mechanism to help prevent accidental moving from neutral to forward or reverse. To release the lock, push in the shift lock button before changing.

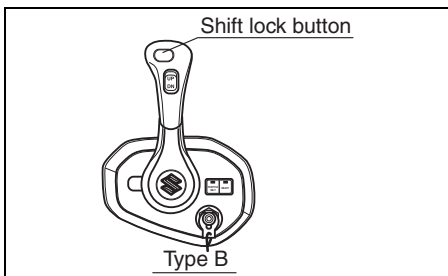

To shift into "FORWARD", move the control handle forward to approximate position (A), as shown in the illustration.

To shift into "REVERSE", move the control handle rearward to approximate position (B), as shown in the illustration.

A detent or notch is present on all Suzuki control boxes to provide a "feel" for positions (A), (B), and neutral. Always shift quickly and firmly from neutral to position (A) or (B) to prevent abnormal wear on the gear and clutch engagement surfaces.

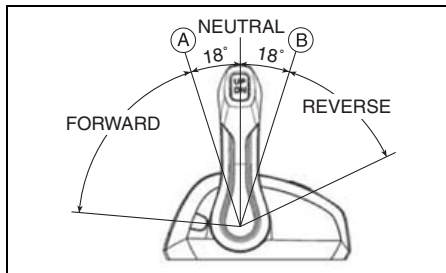

**Speed control**

To increase speed after you have shifted into gear, continue moving the control handle forward or rearward.

**▲ WARNING**

Since the same handle is used for shifting and speed control it is possible to move the handle past the detent and engage the throttle. This can cause the boat to move suddenly resulting in personal injury or property damage.

You must be careful not to move the control handle too far forward or rearward when shifting.

## STOPPING THE ENGINE

### NOTE:

When it is necessary to stop the engine in an emergency, pull the emergency stop switch lock plate by pulling the emergency stop switch cord.

If equipped with Keyless Start System:

To stop the engine:

1. Shift into "NEUTRAL".
2. After operating at full throttle, cool off the engine a few minutes by allowing it to idle or troll at low speed.
3. Quickly press the engine switch to shut off all engines.

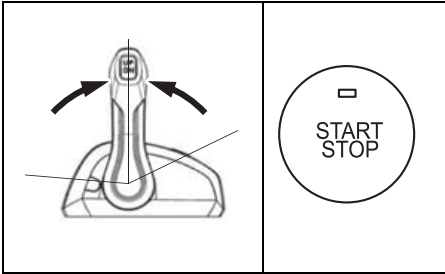

To stop each engine individually, press the switch panel start/stop switch to shut off each engine individually.

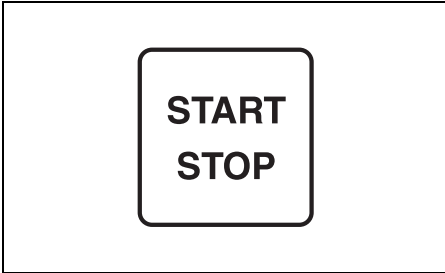

4. Turn the Keyless Start System to OFF (locked) status by one of the following methods.

- Make sure that the keyless fob is within the communication range of the keyless control unit.

Press and hold the engine switch for at least 3 seconds to set Keyless Start System to OFF state. (The buzzer is triggered for one short beep.)

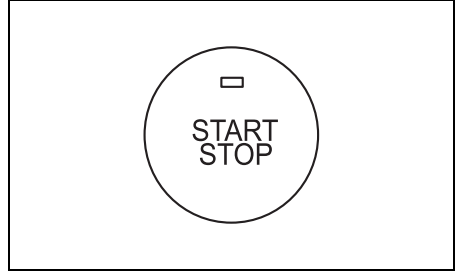

### NOTE:

- While engines are running, press and hold the engine switch for at least 2 seconds to shut off all engines and set Keyless Start System to OFF state.
- Keyless Start System automatically changes to OFF state 15 minutes after the engines are shut off.

- While the keyless fob is within the communication range of the keyless control unit, press the lock button ① on the keyless fob.

The buzzer sounds three times to notify that the Keyless Start System has been turned OFF (locked).

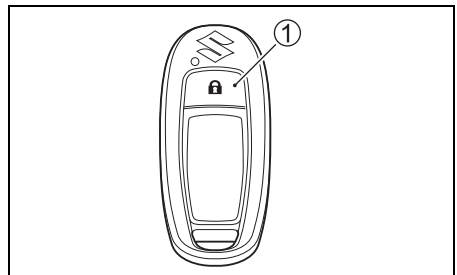

## NOTICE

If the Keyless Start System is in ON state while the engine is not running, the battery will be discharged.

Always turn the Keyless Start System to OFF state when the engine is not running.

## ⚠ WARNING

Unauthorized use of your boat could lead to an accident or damage to your boat.

To prevent unauthorized use of your boat, be sure to remove the key and emergency stop switch lock plate when the boat is unattended.

5. After stopping the engine, disconnect the fuel line from the outboard motor if there is a fuel connector.

## ⚠ WARNING

If you leave the motor stopped for a long period of time with the fuel line connected, fuel can leak out.

Disconnect the fuel line from fuel tank, if there is a fuel connector, whenever you leave the motor stopped for a long period of time.

6. Turn the air-vent screw on the fuel tank cap clockwise to shut the vent (if equipped).

### NOTE:

To make sure that the emergency stop switch operates properly, stop the engine occasionally by pulling out the lock plate, while operating the engine at idling speed.

If not equipped with Keyless Start System:

To stop the engine:

1. Shift into "NEUTRAL".
2. After operating at full throttle, cool off the engine a few minutes by allowing it to idle or troll at low speed.

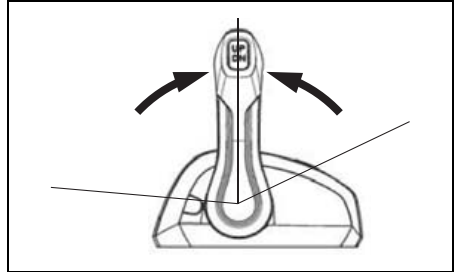

3. Turn the ignition key to the "OFF" position to shut off all engines.

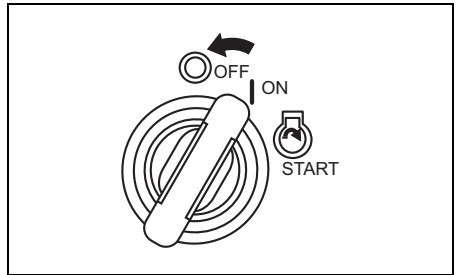

4. To stop each engine individually, press the control panel start/stop switch to shut off each engine individually.

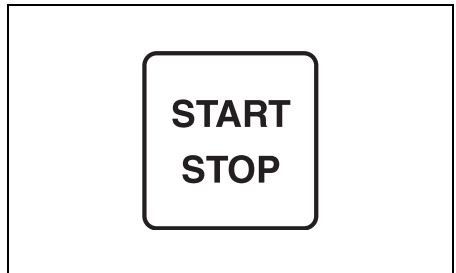

## NOTICE

If the ignition key is left ON when the engine is not running, the battery will discharge.

Always turn the ignition key OFF when the engine is not running.

## ⚠ WARNING

Unauthorized use of your boat could lead to an accident or damage to your boat.

To prevent unauthorized use of your boat, be sure to remove the key and emergency stop switch lock plate when the boat is unattended.

5. After stopping the engine, disconnect the fuel line from the outboard motor if there is a fuel connector.

## ⚠ WARNING

If you leave the motor stopped for a long period of time with the fuel line connected, fuel can leak out.

Disconnect the fuel line from fuel tank, if there is a fuel connector, whenever you leave the motor stopped for a long period of time.

6. Turn the air-vent screw on the fuel tank cap clockwise to shut the vent (if equipped )

### NOTE:

To make sure that the emergency stop switch operates properly, stop the engine occasionally by pulling out the lock plate, while operating the engine at idling speed.

## MOORING

The motor should be tilted up out of the water when you moor the boat in shallow water or if the motor will not be used for some time, to protect it from damage by underwater obstacles at low tide or corrosion from salt water.

Refer to the TILT LOCK LEVER section for details on how to tilt up the motor.

## NOTICE

Improperly securing your boat may cause damage to your boat or motor, or other property damage.

Do not allow your motor to rub against quay walls, piers or other boats when the boat is tied up.

## OPERATION IN SHALLOW WATER

When operating your boat in shallow water, it may be necessary to tilt the motor higher than the normal trim angle. When you tilt the motor beyond the normal trim angle, however, you should only operate the boat at slow speeds. After returning to deep water, be sure to lower the motor to the normal trim angle.

To tilt the motor higher than the normal trim angle, use the Power Trim and Tilt switch.

## ⚠ WARNING

When the motor is beyond the maximum trim position, the swivel bracket will not have side support from the clamp bracket and the tilt system will be unable to cushion the engine if the lower unit strikes an obstruction. This could lead to occupant injury. In addition, beyond the maximum trim position, the water intake holes may be above the water line, which can result in severe engine damage from overheating.

Do not operate the engine above 1500 r/min or operate the boat in a planing attitude with the engine beyond the maximum trim position.

## NOTICE

If the motor hits bottom, serious damage can occur.

Do not allow the motor to hit bottom. If the motor does strike bottom, inspect it immediately for damage.



## OPERATING THE TROLL MODE

### MULTI-FUNCTION GAUGE

#### Switching to TROLL Mode

Press and hold the [MENU] button during cruising operation at Trolling Speed (minimum speed), and this will switch the operation to TROLL Mode.

For the Trolling Speed, the desired engine speed can be set and maintained within the range from 700 r/min to 1200 r/min using the [▼] or [▲] button.

#### NOTE:

Please contact your authorized Suzuki Marine Dealer for more information.

#### Setting the Troll Mode

1. Shift into forward or reverse gear and make sure that the throttle is fully closed (in-gear idle speed).
2. When the [MENU] button is pressed and held in the multi-function gauge screen, the confirmation message "Start Troll Mode?" is displayed.

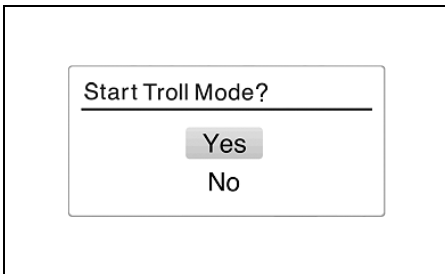

#### 3. When "YES" is selected:

When "YES" is selected and the [SET] button is pressed, one beep sounds to show that it is now in TROLL Mode. At the same time, the screen will change and display the specific TROLL Mode screen, and **TROLL** is displayed on the gauge screen. When the gauge screen displays "Engine Speed Screen" or "All Items Screen", the engine speed screen automatically changes from an analog to a digital display.

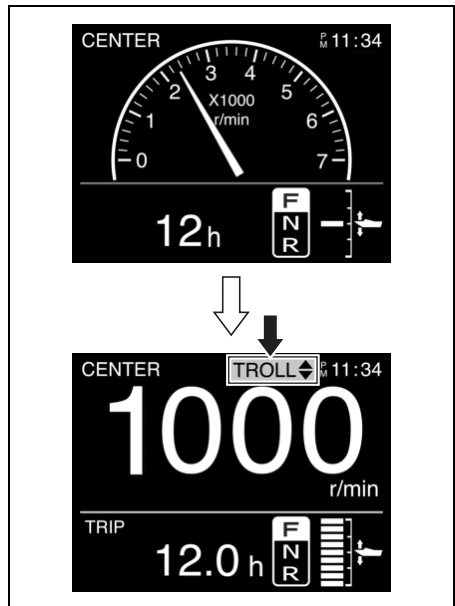

- This icon appears on the screen of the multi-function gauge that was operated to get into the troll mode, and shows operatable multi-function gauge of the troll mode.



- This icon appears on the screen of the multi-function gauge(s) that did not be operated to get into the troll mode. This icon appears on the screen of the multi-function gauge(s) that cannot operate the troll mode.

Example of the troll mode display on the multi-function gauge that can operate the troll mode.

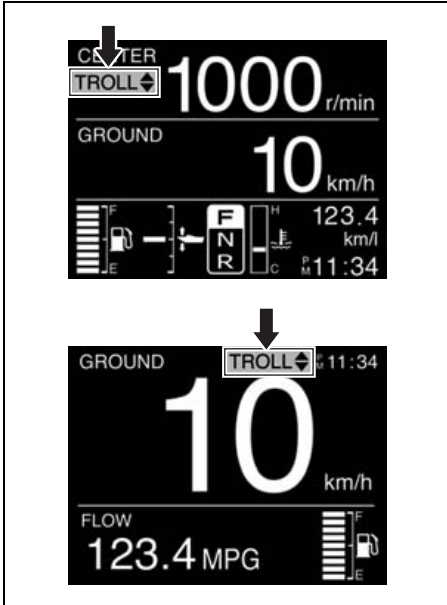

Example of the troll mode display on the multi-function gauge that cannot operate the troll mode.

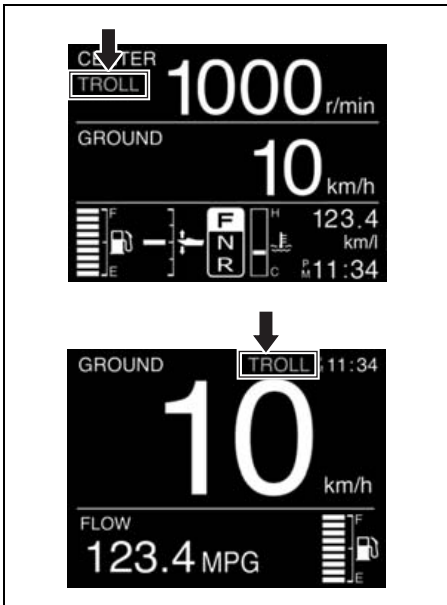

**NOTE:**

- This system will not function properly until engine is at normal operating temperature.
- If the [MENU] button is pressed and held while the remote control lever is in neutral, the mode will not switch to TROLL Mode.
- For the multiple engines:
  - If the throttle of all engines are fully closed and one of engines is in-gear, it shifts to the troll mode when the [MENU] button is pressed.
  - In-gear idle speed of all engines is controlled at the same time.

**When “No” is selected:**

When “No” is selected and the [SET] button is pressed, the display will return to the original gauge screen.

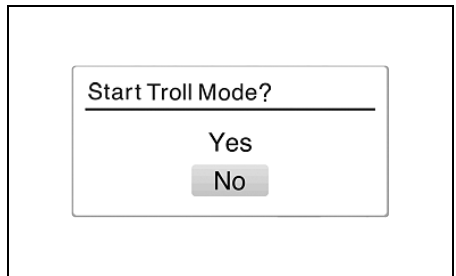

**Adjusting Trolling Speed**

- When pressing the [^] button, one short beep sounds and the engine speed increases by 50 r/min.
- When pressing the [v] button, one short beep sounds and the engine speed decreases by 50 r/min.

**NOTE:**

- When pressing the [✓] button at the lower limit of trolling speed of all engines, the engine speed will not change and three long beeps will sound.
- When pressing the [^] button at the upper limit of trolling speed of all engines, the engine speed will not change and three long beeps will sound.
- For the multiple engines:  
If the button is operated when one engine has reached the adjustment limit of trolling speed, while any other engine has not, one short beep sounds and the rpm of engine which has not reached the adjustment limit changes.
- Shift operation and throttle control remain operational, even in troll mode.

**Cancelling the Troll Mode**

The troll mode can be cancelled by shifting the all remote control levers to the neutral position, or by increasing the engine speed to 3000 r/min or more. In both cases, two short beeps sound when cancelling the troll mode.

**TROLL MODE SWITCH (Optional Item)**

**Switching to TROLL Mode**

Pressing and holding the “UP” or “DN” switch while cruising at Trolling Speed (minimum speed), will switch the mode to TROLL Mode. For the Trolling Speed, the desired engine speed can be set and maintained within the range from 700 r/min to 1200 r/min using the “UP” button or “DN” switch.

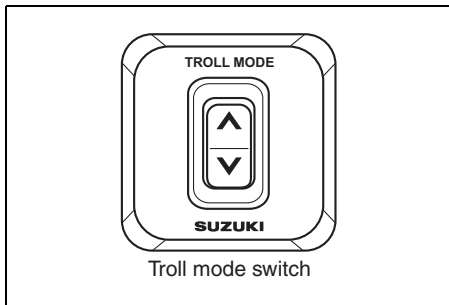

**NOTE:**

Please contact your authorized Suzuki Marine Dealer for more information.

**Setting the Troll Mode**

1. Shift into forward or reverse gear and make sure that the throttle is fully closed (in-gear idle speed).
2. Press the “UP” or “DN” position of the troll mode switch, until you hear one beep. At the same time, the Multi-Function Screen switches over to the TROLL Mode specific screen and **TROLL** is displayed on the gauge screen. When the gauge screen displays “Engine Speed Screen” or “All Items Screen”, the engine speed screen automatically changes from an analog to a digital display.

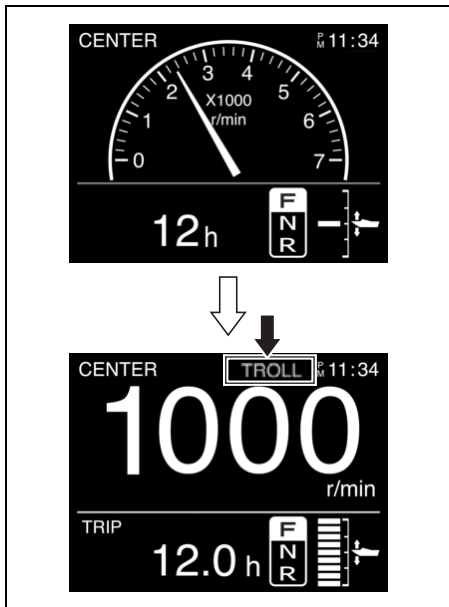

**NOTE:**

- This system will not function properly until engine is at normal operating temperature.
- If the switch is pressed and held while the remote control lever is set to neutral, the mode will not switch to TROLL Mode.
- For the multiple engines:
  - Make sure that both PORT and STBD control handles are shifted into forward or reverse at the fully closed throttle position (in-gear idle speed) before pressing the troll mode switch.
  - In-gear idle speed of all engines is controlled at the same time.

## Adjusting Trolling Speed

- When pressing the “UP” switch, one short beep sounds and the engine speed increases by 50 r/min.
- When pressing the “DN” switch, one short beep sounds and the engine speed decreases by 50 r/min.

### NOTE:

- *When pressing the “DN” switch at the lower limit of trolling speed of all engines, the engine speed will not change and three long beeps will sound.*
- *When pressing the “UP” switch at the upper limit of trolling speed of all engines, the engine speed will not change and three long beeps will sound.*
- *For the multiple engines:  
If the switch is operated when one engine has reached the adjustment limit of trolling speed, while any other engine has not, one short beep sounds and the rpm of engine which has not reached the adjustment limit changes.*
- *Shift operation and throttle control remain operational, even in troll mode.*

### Canceling the Troll mode:

The troll mode can be cancelled by shifting the all remote control levers to the neutral position, or by increasing the engine speed to 3000 r/min or more. In both cases, two short beeps sound when cancelling the troll mode.

## OPERATION IN SALT WATER

After operating the motor in salt water, you should flush the water passages with clean, fresh water as outlined in the FLUSHING THE WATER PASSAGES section. If you do not flush the water passages, salt can corrode the motor and shorten its life.

## OPERATION IN FREEZING WEATHER

When operating your outboard motor in freezing temperatures, you should keep the lower unit submerged in the water at all times.

When taking motor out of the water, stand it up in a vertical position until the cooling system drains completely.

### **NOTICE**

**If you leave your outboard motor out of the water in freezing temperatures with water still in the cooling system, the water can freeze and expand, causing severe damage to the motor.**

**When your outboard is in the water in freezing temperatures, keep the lower unit submerged in the water at all times. When the motor is stored out of the water in freezing temperatures stand it up in the vertical position so that the cooling system drains completely.**

# MOTOR REMOVAL AND TRANSPORTING

## MOTOR REMOVAL

If it is necessary to remove the outboard motor from your boat, we recommend that you ask your authorized Suzuki Marine Dealer to do the work for you.

## MOTOR TRANSPORTING

When transporting the motor, place the motor either vertically or horizontally.

### Vertical transport:

Attach the motor to the carrier by securing clamp bracket with two sets of transom bolt and nut.

Never use display stand for transportation of the motor.

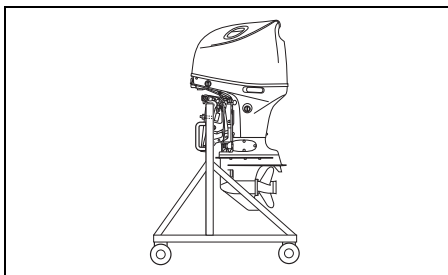

### Horizontal transport:

1. Drain the engine oil. Refer to the ENGINE OIL section.

2. Drain the gasoline from the vapor separator as follows:

(1) Remove the motor cover.

(2) Remove the eight (8) bolts using a 8 mm box wrench, then remove the starboard side cover ①.

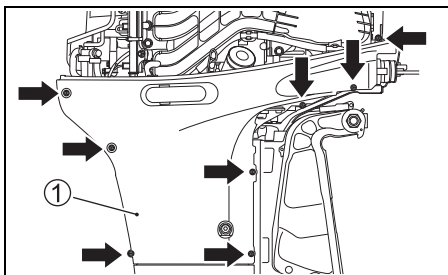

(3) Pull the drain hose end ② out.

(4) Loosen the vapor separator drain screw ③ and drain the gasoline into a suitable container.

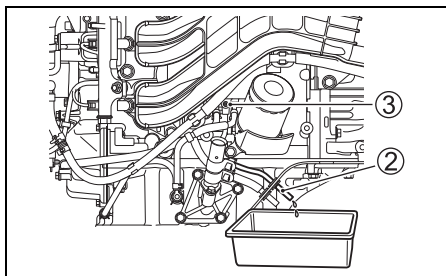

## ▲ WARNING

**Gasoline is extremely flammable and toxic. It can cause a fire and can be hazardous to people and pets.**

**Use a proper, safe container to store any gasoline drained from the outboard motor. Keep gasoline away from sparks, flames, people, and pets.**

## NOTICE

**If spilled gasoline is just left on painted surface, it may cause a stain or discoloration of the surface coating.**

**Wipe off any spilled gasoline immediately with a soft cloth etc.**

(5) After draining, retighten the drain screw ③ and install the motor cover.

3. Rest the motor on a case protector with the port side downwards as shown.

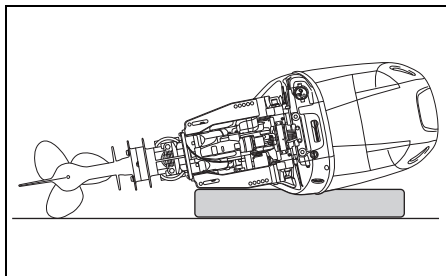

## **▲ WARNING**

Spilled fuel or fuel vapor can cause a fire and is hazardous to health.

Always take the following precautions:

- Drain the fuel from the fuel line and fuel vapor separator before transporting the boat/outboard motor and before removing the motor from the boat.
- DO NOT lay motor on its side without draining fuel.
- Keep the motor away from open flames or sparks.
- Wipe up spilled fuel immediately.

## **NOTICE**

If you are not careful when resting the outboard on its side and do not take proper precautions such as first draining the engine oil and cooling water completely, damage can occur. Engine oil may enter the cylinder from the sump, water may enter the cylinder through the exhaust port, or the outer casings may be damaged.

Always drain the engine oil and cooling water completely before laying the motor on its side, and be careful laying the motor down.

## **NOTICE**

If you let the lower unit of your outboard sit higher than the power head during transporting or storing, water may trickle into the power head, causing damage to the engine.

Never let the lower unit sit higher than the power head when transporting or storing your outboard.

## **TRAILERING**

When trailering your boat with the motor attached, keep the motor in the normal operating position unless there is not enough ground clearance. If you need more ground clearance, trailer the motor in a tilted position using a transom saver bar or similar device to support the weight of the motor.

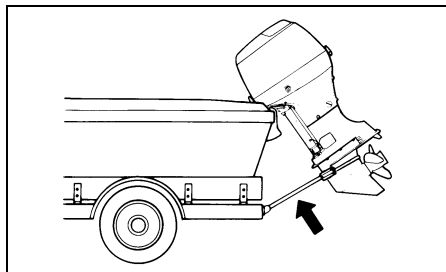

## **NOTICE**

If you use the tilt lock lever to hold the motor in the fully tilted up position when trailering the boat, towing motion or poor road surfaces may cause unexpected tilt lock release, resulting in damage to the motor and the tilt lock mechanism.

Never use the tilt lock lever to hold the motor in the fully tilted up position when trailering the boat. Use a transom saver bar or similar device to support the weight of the motor.

# INSPECTION AND MAINTENANCE

## MAINTENANCE SCHEDULE

It is important to inspect and maintain your outboard motor regularly. Follow the chart below. At each interval, be sure to perform the indicated service. Maintenance intervals should be judged by number of hours or number of months, whichever comes first.

### ▲ WARNING

Exhaust gas contains carbon monoxide, a dangerous gas that is difficult to detect because it is colorless and odorless. Breathing carbon monoxide can cause death or severe injury.

Never start the engine or let it run indoors or where there is little or no ventilation.

Interval Item to be serviced	Initial 20 hrs. or 1 month	Every 100 hrs. or every 12 months	Every 200 hrs. or every 12 months	Every 300 hrs. or every 36 months
Spark plug		I		
Breather & Fuel line	I	I		
Engine oil	R	R		
Gear oil	R	R		
Lubrication	I	I		
Anodes (external)	I	I		
* Anodes (internal cylinder block/cylinder head)		I		
Bonding wires	I	I		
Battery	I	I		
* Engine oil filter	R		R	
Low pressure fuel filter	I	I		
	Replace every 400 hours or every 2 years.			
* Idle speed	I		I	
* Valve clearance (lash)				I
* Water pump			I	
* Water pump impeller			I	R
* Propeller nut & pin	I	I		
* Bolts & Nuts	T	T		
* Thermostat		I		
MPC filter		I		

I: Inspect and clean, adjust, lubricate, or replace, if necessary T: Tighten R: Replace

### NOTE:

*Water-separating fuel filter*

*Replace the filter element every 12-months (or more frequently if recommended by the filter manufacturer).*

## ⚠ WARNING

Improper maintenance or failure to perform recommended maintenance can be hazardous. Poor maintenance or lack of maintenance increases the chance of an accident or equipment damage.

Be sure to have maintenance performed according to the schedule in the above chart. Suzuki recommends that only your authorized Suzuki marine dealer or a qualified service mechanic perform maintenance on those items in the chart above which are marked with an asterisk (\*). You may perform maintenance on the unmarked items by referring to the instructions in this section if you have mechanical experience. If you are not sure whether you can successfully complete any of the unmarked maintenance jobs, ask your authorized Suzuki marine dealer to do the maintenance for you.

## ⚠ WARNING

The safety of you and your passengers depends on how well you maintain your outboard motor.

Follow all inspection and maintenance instructions carefully. If you do not have prior mechanical experience, do not attempt to perform maintenance on your outboard motor. You could be injured or may damage the motor.

## NOTICE

The maintenance intervals in the chart are designed for normal usage of your outboard motor. If your outboard motor is used under severe conditions as outlined below, you may need to perform maintenance more often than indicated in the chart.

- Frequent full throttle operation
- Prolonged continuous operation at the maximum speed
- Prolonged continuous operation at idling speed or trolling speed
- Frequent operation in muddy, silty, sandy, acidic or shallow water
- Operation without appropriate warmup

- Frequent abrupt acceleration and deceleration
  - Frequent shift operation
- Failure to perform maintenance more frequently could result in damage.

Consult your authorized Suzuki marine dealer regarding appropriate maintenance intervals for your usage conditions. When replacing parts on your outboard motor, Suzuki strongly recommends that you use genuine Suzuki parts or their equivalent.

## TOOL KIT

A tool kit is provided with your outboard motor. Keep the kit on board your boat and make sure that all of the items provided remain in the kit. The tool kit contains the following items:

- ① Tool bag
- ② 8 mm Box wrench
- ③ 16 mm Box wrench
- ④ 8 × 10 mm Box wrench
- ⑤ 10 × 12 mm Spanner
- ⑥ 14 × 17 mm Spanner
- ⑦ Combination screw driver
- ⑧ Screwdriver handle
- ⑨ Pliers
- ⑩ Hexagon wrench 8 mm
- ⑪ Engine oil drain plug gasket (spare)

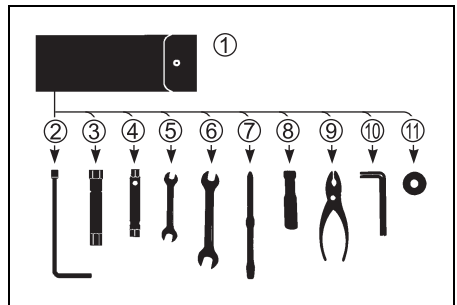



## SPARK PLUG

Remove the spark plugs as follows:

1. Remove the fuel hose guard ①.

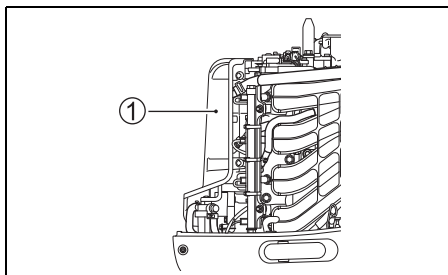

2. Remove the bolt securing the ignition coil.
3. Pull out the ignition coil.
4. Loosen and remove the spark plug using the box wrench and spanner in the tool bag.

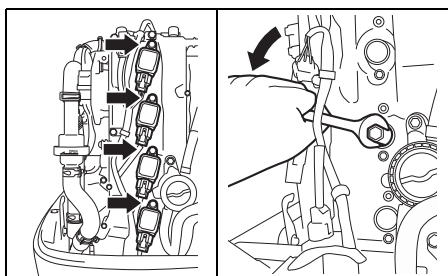

Your outboard motor comes equipped with the following "standard" spark plug for normal usage.

NGK LKR6E	Standard
-----------	----------

### NOTICE

Non-resistor types of spark plugs will interfere with the function of the electronic ignition, causing misfiring, or causing problems with other electronic boat equipment and accessories.

Use **ONLY** resistor type spark plugs in your outboard motor.

A normally operating spark plug is very light-brown in color. If the standard plug is not suitable for your operating, consult your authorized Suzuki Marine Dealer.

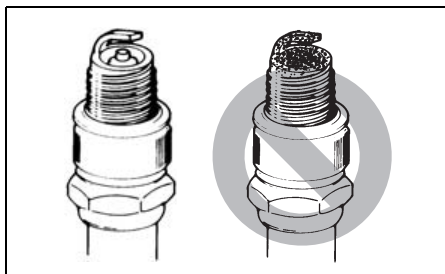

### NOTICE

Use of improper spark plugs or improperly tightening spark plugs can cause severe engine damage.

- Do not experiment with other spark plug brands unless you can determine that they are directly equivalent to the specified brand, or you may experience engine damage which will not be covered under warranty. Note that aftermarket cross-reference charts may not be accurate.
- To install a spark plug; seat it as far as possible by hand, then use a wrench to tighten it to either the recommended torque setting or the specified rotation angle.

Tightening torque	
15 – 19 N·m (1.5 – 1.9 kgf·m, 11 – 14 lbf·ft)	
Rotation angle	
New plug	1/2 – 3/4 of a turn
Re-use plug	1/12 – 1/8 of a turn

- Do not overtighten or cross-thread a spark plug, as this will damage the aluminum threads of the cylinder head.

To maintain a strong spark, you should clean and adjust the plugs at the intervals shown in the maintenance chart. Remove carbon deposits from the spark plugs using a small wire brush or spark plug cleaner, and adjust the gap according to the following chart:

Spark plug gap	0.8 – 0.9 mm (0.031 – 0.035 in)
----------------	------------------------------------

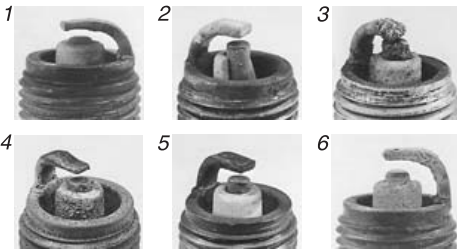
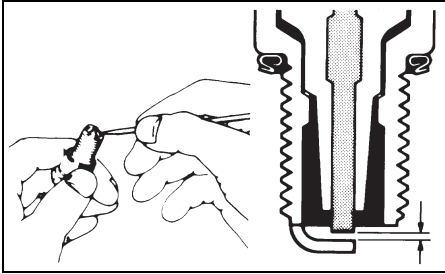

1. Excessive wear    2. Breakage    3. Melting  
4. Erosion    5. Yellow deposits    6. Oxidation

**NOTE:**

*If the spark plug condition is found as shown in the illustration above, ensure it is replaced with new one. Otherwise, it will cause difficulty in starting the engine, increase fuel consumption, and result in engine troubles.*

## BREATHER AND FUEL LINE

Inspect the breather and fuel line for leaks, cracks, swelling, or other damage. If the breather and fuel line is damaged in any way, it must be replaced. Consult your authorized Suzuki Marine Dealer if it is necessary to replace them.

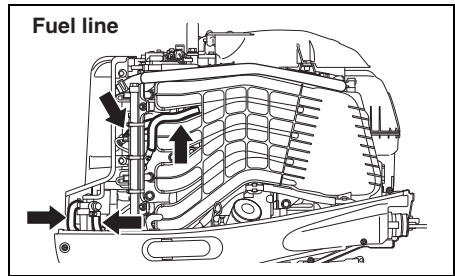
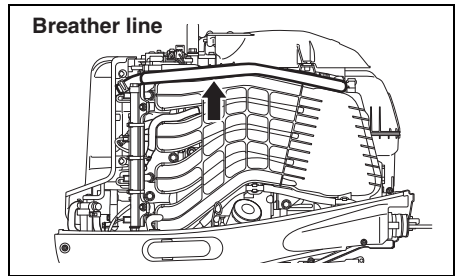

**⚠ WARNING**

**Fuel leakage can contribute to an explosion or fire, resulting in serious personal injury.**

**Have your authorized Suzuki Marine Dealer replace the fuel line if there is any evidence of leaking, cracking or swelling.**

## ENGINE OIL

### **▲ WARNING**

Never perform any ENGINE OIL procedure with the motor running, as serious injury can occur.

The motor must be shut off before any ENGINE OIL procedures are performed.

### **NOTICE**

Extended trolling can reduce oil life. Your engine may be damaged if you do not change engine oil more frequently under this type of use.

Change your engine oil more frequently if your engine is used for extended trolling.

### **Engine oil change**

The oil should be changed when engine is warm so that the oil will drain thoroughly from the engine.

To change the engine oil:

1. Place the motor in a vertical position and remove the motor cover.
2. Remove the oil filler cap.

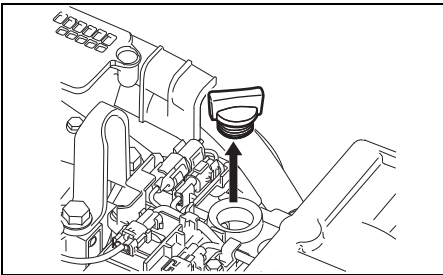

3. Place a drain pan under the engine oil drain screw.

### **▲ CAUTION**

The engine oil temperature may be high enough to burn your fingers when the drain plug is loosened.

Wait until the drain plug is cool enough to touch with bare hands before removing it.

4. Remove the engine oil drain screw ① and gasket ②, then let the engine oil drain.

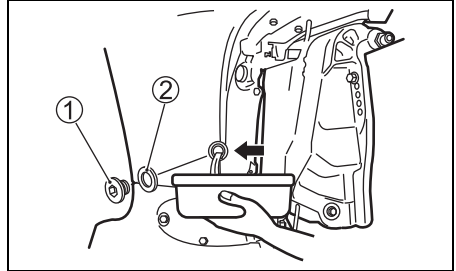

5. After draining, secure the engine oil drain screw with a new gasket.

### **NOTICE**

A previously-used gasket may leak, resulting in engine damage.

Do not re-use gaskets. Be sure to always use new gaskets.

### **NOTE:**

There are spare gaskets in the tool bag.

6. Fill with recommended engine oil to the upper level.

Oil capacity: 5.5 L

Engine oil: Refer to the ENGINE OIL section of this manual.

7. Check the engine oil level.

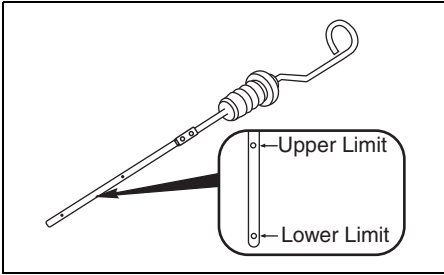

**NOTE:**

To avoid incorrect measurement of engine oil level, check oil level only when the engine has cooled.

8. Reinstall the oil filler cap.

**▲ WARNING**

Engine oil can cause injury to people or pets. Repeated, prolonged contact with used engine oil may cause skin cancer. Even brief contact with used oil may irritate skin.

- Keep new and used oil away from children and pets.
- Wear a long-sleeve shirt and waterproof gloves when handling oil.
- Wash with soap if oil contacts your skin.
- Launder any clothing or rags that are wet with oil.

**NOTE:**

Recycle or properly dispose of used engine oil. Do not throw it in the trash, or pour it on the ground, down a drain, or into the water.

## GEAR OIL

To check the gear oil level, remove the upper oil level plug and look into the hole. The oil level should be at the bottom edge of the hole. If the oil level is low, add the specified gear oil until the level reaches the bottom edge of the hole. Then, reinstall and tighten the plug.

To change the gear oil:

1. Make sure the motor is in an upright position. Place a drain pan under the lower casing.
2. Remove the gear oil drain plug ①, then remove the gear oil level plug ②.

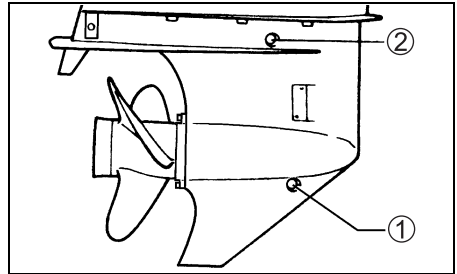

3. After the oil has drained completely, inject the specified gear oil into the lower drain hole until it just starts to come out of the upper level hole. Approximately 1.05 L (1.11/0.92 US/Imp qt.) of oil will be required.
4. Reinstall and tighten the gear oil level plug ②, then quickly reinstall and tighten the gear oil drain plug ①.

**NOTE:**

To avoid insufficient injection of gear oil, check the gear oil level 10 minutes after doing the procedure in the step 4. If the oil level is low, slowly inject the gear oil up to the correct level.

## **⚠ WARNING**

Gear oil can cause injury to people or pets. Repeated, prolonged contact with used gear oil may cause skin cancer. Even brief contact with used oil may irritate skin.

- Keep new and used oil away from children and pets.
- Wear a long-sleeve shirt and waterproof gloves when handling oil.
- Wash with soap if oil contacts your skin.
- Launder any clothing or rags that are wet with oil.

### **NOTE:**

*Recycle or properly dispose of used gear oil. Do not throw it in the trash, or pour it on the ground, down a drain, or into the water.*

## **NOTICE**

If fishing line wraps around the rotating propeller shaft, the propeller shaft oil seal can become damaged and can allow water to enter the gear case causing severe damage.

If the gear oil has a milky color, it is contaminated with water. Immediately contact your authorized Suzuki marine dealer for advice. Do not operate your outboard until the oil is changed and the cause of the contamination is corrected.

## **LOW PRESSURE FUEL FILTER**

The low pressure fuel filter must be replaced by an authorized Suzuki Marine Dealer periodically.

Replace low pressure fuel filter at every 400 hours (2 years).

## **⚠ WARNING**

Gasoline is extremely flammable and toxic. It can cause a fire and can be hazardous to people and pets.

Always take the following precautions when servicing the fuel filter:

- Stop the motor before cleaning the fuel filter.
- Be careful not to spill fuel. If you do, wipe it up immediately.
- Do not smoke, and keep away from open flames and sparks.

## **⚠ WARNING**

Cleaning solvent is toxic and an irritant, and can cause injury to people and pets.

Keep solvent away from children and pets. Dispose of solvent properly when you are finished.

Inspect and clean the fuel filter as follows:

1. Turn the engine off and allow it to cool.
2. If equipped with Keyless Start System:  
Make sure that the keyless start system is in OFF state.  
  
If not equipped with Keyless Start System:  
Make sure that the ignition key is in the OFF position.
3. Remove the fuel hose guard ①.

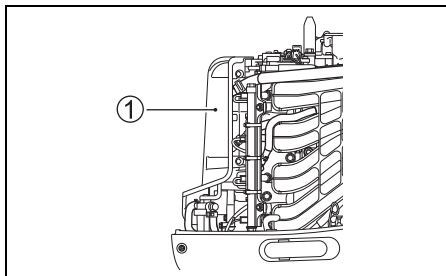

## NOTICE

Improperly loosening the filter cup can cause sensor lead wire damage.

- Be careful not to twist the sensor lead wire when removing the filter cup.
- Disconnect the lead wire connector before removing the filter cup.

4. Push the connector lock tab "a", then disconnect the water sensor lead wire connector ②.

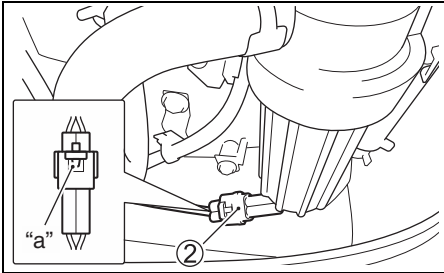

5. Place a rag under the filter before removal to catch any spilled fuel.
6. Separate the filter cup ③ from the cap ④ by turning the filter cup counterclockwise.

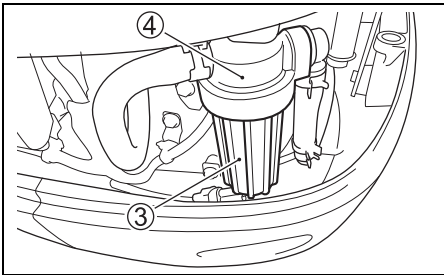

7. Drain the fuel and water in the filter cup into a suitable container.

## NOTICE

If spilled gasoline is just left on painted surface, it may cause a stain or discoloration of the surface coating.

Wipe off any spilled gasoline immediately with a soft cloth etc.

8. Pull out the filter element ⑤. Inspect the filter element ⑤, O-ring ⑥ and seal ring ⑦ for damage. If they are damaged, replace them.

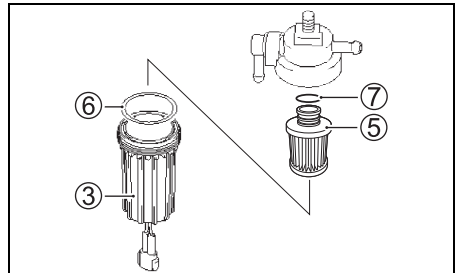

9. Wash the filter element with clean solvent and dry it.
10. Reinstall the seal ring and filter element in their original positions.
11. Verify that the O-ring is in place in the top of the filter cup and screw the filter cup back into place.
12. Connect the water sensor lead wire connector ②.
13. Reinstall the fuel filter with bracket by securing the bolt and nut.
14. Restart the engine and check that there are no leaks around the fuel filter.

### NOTE:

If any water exists in the fuel filter cup, remove the cup and drain the water. Always dispose of excess fuel safely. For questions, consult your authorized Suzuki Marine Dealer.

## MPC FILTER

Inspect the MPC filter for dust and clogged elements.

Have your authorized Suzuki marine dealer replace the MPC filter if there is any evidence of clogging.

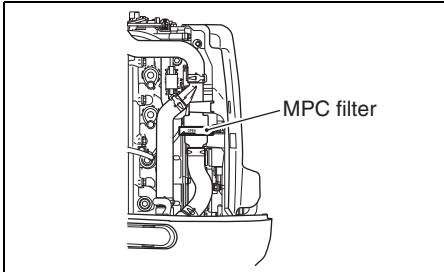

Inspect and clean the MPC filter as follows:

### ▲ CAUTION

The engine temperature may be high enough to burn your fingers.

Before inspecting the MPC filter, ensure that the engine is sufficiently cooled.

1. Make sure that the motor is stopped.
2. Turn off the power and pull out the emergency stop switch lock plate.
3. Remove the fuel hose guard.

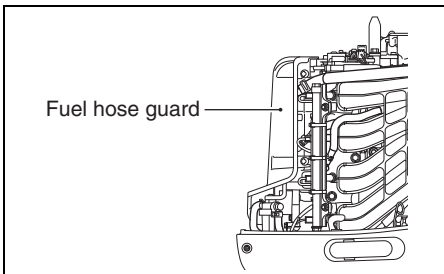

4. Separate the filter case cap ① from the filter lower case ② by turning the filter case cap clockwise.

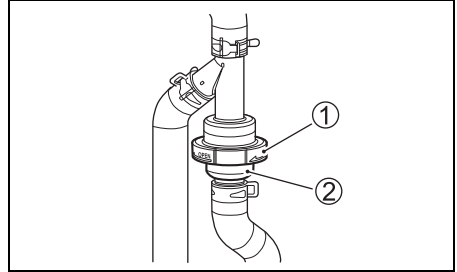

5. Remove the filter ③.

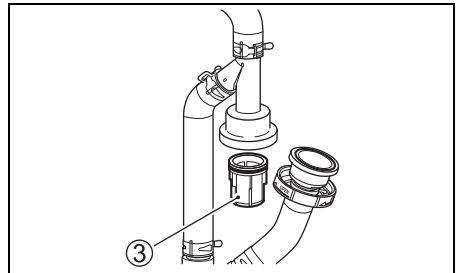

6. Inspect the case cap ①, lower case ②, filter ③, O-ring ④, ⑤ and upper case ⑥ for damage. If they are damaged, replace them.

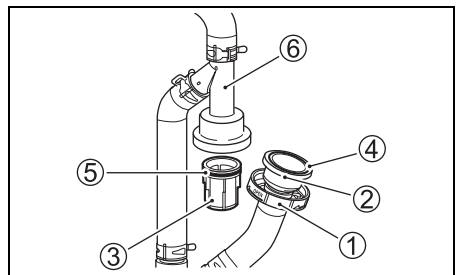

7. Clean the filter ③.
8. Apply soapy water to O-ring ⑤.
9. Reinstall the filter ③ and lower case ② in their original positions, and tighten case cap ①.
10. Restart the engine and check that there are no leaks around the MPC filter.

# LUBRICATION

Proper lubrication is important for the safe, smooth operation and long life of each working part of your outboard motor. The following chart shows the lubrication points of your motor and the recommended lubricant:

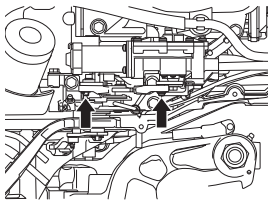
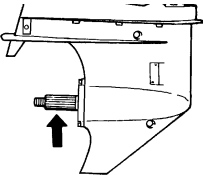
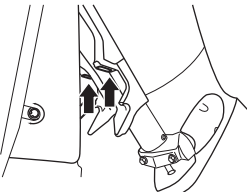
LOCATION	LUBRICANT
 <p data-bbox="169 480 255 501">Shift link</p>	<p data-bbox="364 596 516 671">Marine-grade water resistant grease</p>
 <p data-bbox="138 724 288 745">Propeller shaft</p>	
 <p data-bbox="87 975 337 995">Trim ram pad (DF140BG)</p>	

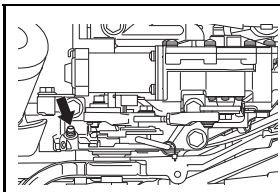

Clutch lever

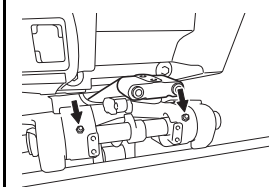

Swivel bracket

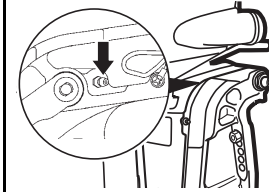

Marine-grade water resistant grease (Grease Gun)

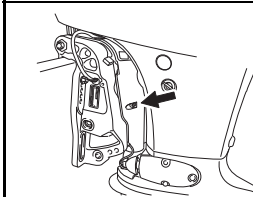

DF115BG transom "L"

Steering bracket

**NOTE:**

Before applying grease through the steering bracket grease nipple, lock the motor in the fully tilted up position.



## ANODES AND BONDING WIRES

### Anodes

The motor is protected from exterior corrosion by anodes. These pieces of anodes control electrolysis and prevent corrosion. The anodes will corrode in place of the parts they are protecting. You should periodically inspect each of the anodes and replace them when 2/3 of the metal has corroded away.

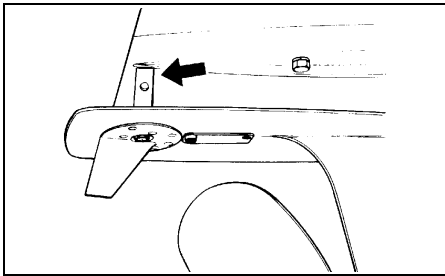
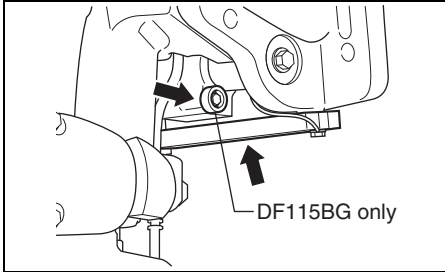

### NOTICE

If anodes are not properly maintained, underwater aluminum surfaces (such as the lower unit) will suffer galvanic corrosion damage.

- Periodically inspect anodes to make sure they have not become detached.
- Do not paint anodes, as this will render them ineffective.
- Periodically clean anodes with a wire brush to remove any coating which might decrease their protective ability.

### NOTE:

Consult your authorized Suzuki Marine Dealer for inspection and replacement of internal anodes attached to the cylinder block/cylinder head.

### Bonding wires

Bonding wires are used to electrically connect the engine components so they exist in a common ground circuit. This allows them to be protected against electrolysis by the anodes. These wires and their terminals should be checked periodically to be sure they have not been damaged.

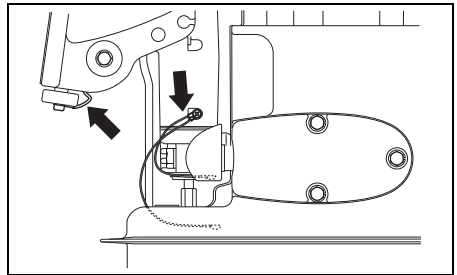
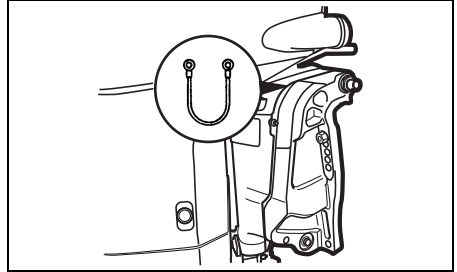

## BATTERY

The battery solution level must be kept between the MAX and the MIN level lines at all times. If the level drops below the MIN level line, add DISTILLED WATER ONLY until the battery solution level reaches the MAX level line.

### WARNING

Battery acid is poisonous and corrosive, and can cause severe injury.

Avoid contact with eyes, skin, clothing, and painted surfaces. If battery acid comes in contact with any of these, flush immediately with large amounts of water. If acid contacts the eyes or skin, get immediate medical attention.

### WARNING

If you are not careful when checking or servicing the battery, you can cause a short circuit, which could result in an explosion, fire, or circuit damage.

Disconnect the negative (black) cable when checking or servicing the battery. Be careful not to allow a metal tool or other metal object to touch the battery's positive terminal and the motor at the same time.

### WARNING

Battery posts, terminals, and related accessories contain lead and lead compounds that may be hazardous.

Wash hands after handling.

### NOTICE

If you add diluted sulphuric acid to the battery after it has been initially serviced, you will damage the battery.

NEVER add diluted sulphuric acid to the battery after it has been initially serviced. Follow the battery manufacturer's instructions for specific maintenance procedures.

## ENGINE OIL FILTER

The engine oil filter must be changed by authorized Suzuki Marine Dealer periodically. Replace engine oil filter with a new one at initial 20 hours (1 month).

Replace engine oil filter with a new one at every 200 hours (12 months).

# FLUSHING THE WATER PASSAGES

After operation in muddy, brackish, or salt water, you should flush the water passages and motor surface with clean, fresh water.

If you do not flush the water passages, salt can corrode the motor and shorten its life. Flush the water passages as follows.

## ENGINE RUNNING – Vertical position –

Suzuki recommends that you flush the water passages by using this method.

To flush the water passages, you must obtain a commercially available engine flush device.

### ▲ WARNING

Exhaust gas contains carbon monoxide, a dangerous gas that is difficult to detect because it is colorless and odorless. Breathing carbon monoxide can cause death or severe injury.

Never start the engine or let it run indoors or where there is little or no ventilation.

### ▲ WARNING

Failure to take proper precautions when flushing the water passages can be hazardous.

When flushing the water passages, always take the following precautions:

- Make sure that the engine remains in NEUTRAL. If shifted into gear, the propeller shaft will turn and could cause severe personal injury.
- Make sure the motor is properly clamped to a secure stand or boat, and remain in attendance until flushing is completed.
- Keep children and pets away from the area, and stay clear of all moving parts.

### NOTICE

Severe engine damage can occur in as little as 15 seconds if the engine is started without supplying water to the cooling system.

Never start the motor without supplying water to the cooling system.

1. Make sure that the motor is stopped.
2. Install the flushing attachment ① so that the water intake holes are covered by the rubber cups on the attachment.
3. Connect a garden hose to the flushing attachment and turn on the water to obtain enough flow so that plenty of excess water is flowing out from around the rubber cups on the attachment.

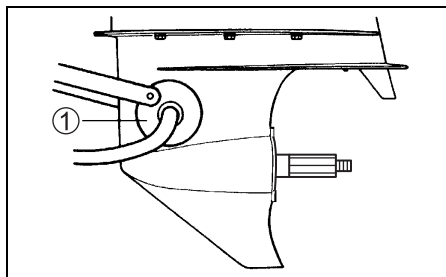

4. Place the remote control handle in the "NEUTRAL" position with the propeller removed, start the motor and allow it to run at idle.
5. Readjust the water flow, if necessary, so that there is still plenty of excess water flowing out from around the rubber cups.
6. Allow the water to continue circulating for a few minutes.
7. Stop the motor, then turn off the water.
8. Remove the flushing attachment from the water intake hole.
9. Clean the motor surface and apply a coat of automotive wax on the external finish of the motor.

## ENGINE NOT RUNNING

### – Vertical position –

1. Make sure that the motor is stopped.
2. Remove the plug (A) or (C) from the flushing port.

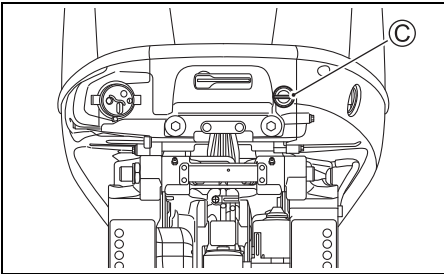
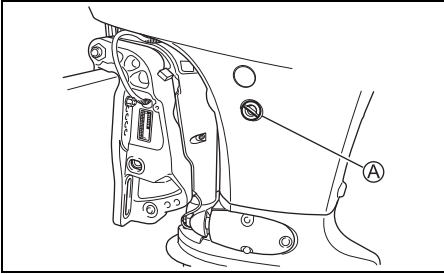

3. Install garden hose by using a hose connector matched to flushing port thread (B).  
Thread (B): 0.75 – 11.5 NHR (American standard hose coupling threads for garden hose applications.)

#### NOTE:

The hose connector (flushing attachment) matched to the flushing point thread (B) is included in the crate parts.

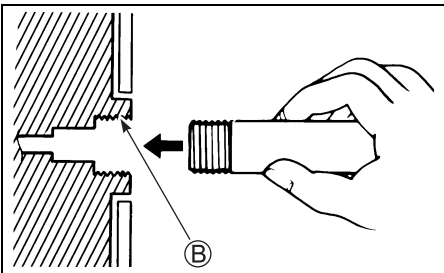

4. Turn on the water to obtain a good water flow. Flush the engine for about five minutes.
5. Turn off the water.
6. Remove the hose and connector (if used) then reinstall the plug into the flushing port.
7. Leave the motor in a vertical position until the engine is drained completely.

## ENGINE NOT RUNNING

### – Full tilt up position –

1. Raise the engine to the full tilt up position.
2. Follow the “ENGINE NOT RUNNING – Vertical position” instructions.  
**DO NOT RUN ENGINE IN THE FULL TILT UP POSITION.**
3. Lower the motor to a vertical position until the engine is drained completely.

# SUBMERGED MOTOR

A motor that has been accidentally submerged in water must be overhauled as soon as possible to prevent corrosion. In the event that your motor is accidentally submerged, take the following steps:

1. Get the motor out of the water as soon as possible.
2. Wash it thoroughly with fresh water to completely remove all salt, mud, and seaweed.
3. Remove the spark plugs. Drain the water from the cylinders through the spark plug holes by manually turning the flywheel several times.
4. Check if any water is evident in the engine oil. If water is seen, remove the oil drain plug and drain the oil. After draining, tighten the oil drain plug.
5. Drain the fuel line.

## **WARNING**

**Gasoline is extremely flammable and toxic. It can cause a fire and can be hazardous to people and pets.**

**Keep flames and sparks away from gasoline. Dispose of unwanted fuel properly.**

6. Pour engine oil into the engine through the spark plug holes. Coat the engine inner parts with oil by manually turning the flywheel several times.

## **NOTICE**

**Severe engine damage may occur if you continue cranking the engine when you encounter friction or resistance.**

**If you encounter friction or resistance while cranking the engine, stop at once and do not attempt to start the engine until you find and correct the problem.**

7. Take the motor to your authorized Suzuki Marine Dealer as soon as possible to be overhauled.

## **NOTICE**

**If the fuel supply is contaminated with water, engine damage may occur.**

**If the boat's fuel tank filler and vent were submerged, inspect the fuel supply to make sure it is not contaminated with water.**

# STORAGE PROCEDURE

## MOTOR STORAGE

When storing your motor for a long period of time (for example, at the end of the boating season), it is recommended that you take your motor to your authorized Suzuki Marine Dealer. However, if you choose to prepare the motor for storage yourself, follow the procedure outlined below:

1. Change the gear oil as outlined in the GEAR OIL section.
2. Change the engine oil as outlined in the ENGINE OIL section.
3. Fill a fuel stabilizer to the fuel tank according to the instructions on the stabilizer can.
4. Flush the water passages in the motor thoroughly. Refer to the FLUSHING THE WATER PASSAGES (Engine running) section.
5. Readjust the water flow, run the engine at about 1500 r/min in neutral for five minutes to distribute the stabilized fuel through the engine.
6. Stop the engine. Then turn off the water and disconnect the flushing attachment.
7. Lubricate all other specified parts. Refer to the LUBRICATION section.
8. Wash the exterior of the engine with fresh water. After washing, the water remaining on the engine should be wiped off with dry clothes.  
High pressure washer should be used only for washing exterior. And the nozzle of the high pressure washer should be well away from the engine.
9. Apply a coat of automotive wax on the external finish of the motor. If paint damage is evident, apply touch up paint before waxing.
10. Store the motor in an upright position in a dry, well-ventilated area.

### WARNING

**When the engine is running, there are many moving parts that could cause severe personal injury.**

**When the engine is running, keep your hands, hair, clothing, etc., away from the engine.**

### NOTICE

**Severe engine damage can occur in as little as 15 seconds if the engine is started without supplying water to the cooling system.**

**Never start the motor without supplying water to the cooling system.**

## BATTERY STORAGE

1. When the outboard motor will not be used for a month or longer, remove the battery and store it in a cool, dark place. Completely recharge the battery before reusing it.
2. If the battery will be stored for a long period of time, check the specific gravity of the battery solution at least once a month and recharge the battery when low.

### WARNING

**Failure to take proper precautions when charging the battery can be hazardous. Batteries produce explosive vapors that can ignite. Battery acid is poisonous and corrosive, and can cause severe injury.**

- Do not smoke and keep battery away from open flames and sparks.
- To avoid creating a spark when charging the battery, connect the battery charger cables to the proper terminals before turning the charger on.
- Handle the battery with extreme care and avoid skin contact with battery acid.
- Wear proper protective clothing (Safety glasses, gloves, etc.)

## AFTER STORAGE

When taking your motor out of storage, follow the procedure below to return it to operating condition:

1. Thoroughly clean the spark plugs. Replace them if necessary.
2. Check the gear-case oil level and if necessary, add gear oil according to the procedure outlined in the GEAR OIL section.
3. Lubricate all moving parts according to the LUBRICATION section.
4. Check the engine oil level.
5. Clean the motor and wax the painted surfaces.
6. Recharge the battery before installing it.

## TROUBLESHOOTING

This troubleshooting guide is provided to help you find the cause of common complaints.

### **NOTICE**

**Failure to troubleshoot a problem correctly can damage your outboard motor. Improper repairs or adjustments may damage the outboard motor instead of fixing it. Such damage may not be covered under warranty.**

**If you are not sure about the proper action to correct a problem, consult your Suzuki marine dealer.**

### **Starter motor will not operate:**

- Emergency stop switch lock plate is not in position.
- Starter relay fuse is blown out.
- Sub battery cable fuse is blown out.
- Control handle is not in NEUTRAL.
- Battery terminal connection is corroded or lost.
- Battery power is lost.
- Starter motor is failed.
- If equipped with Keyless Start System:  
Engine switch or start/stop switch is failed.  
If not equipped with Keyless Start System:  
Ignition switch or start/stop switch is failed.
- Electric wiring connection is loose.

### **Engine will not start (hard to start):**

- Fuel tank is empty.
- Fuel is deteriorated.
- Engine starting procedure is mistaken.
- Fuel tank air vent is not opened.
- Fuel hose is not properly connected to engine.
- Fuel hose is kinked or pinched.
- Fuel filter is clogged.
- Fuel pump is failed.
- Fuel tank filter is clogged.
- Spark plug is fouled.
- Ignition system is fouled.
- Electric wiring connection is loose.

**Engine idles unstably or stalls:**

- Spark plug is fouled.
- Fuel hose is kinked or pinched.
- Fuel hose is not properly connected to engine.
- Fuel is deteriorated.
- Fuel filter is clogged.
- Fuel pump is failed.
- Ignition system is fouled.
- Incorrect engine oil is used.
- Thermostat is failed.
- Electric wiring connection is loose.

**Caution system is activated (Caution buzzer sounds. Caution LEDs light.):**

- Cooling water passage is clogged.
- Thermostat is failed.
- Water pump is failed.
- Oil change reminder system is activated.
- Engine oil level is not enough or deteriorated.
- Engine oil filter is clogged.
- Oil pump is failed.
- Propeller is damaged.
- Battery power is lost.
- Engine control sensor is failed.
- Electric wiring connection is loose.

**Shift operation will not be activated:**

- Electronic shift control system is failed.

**Propeller is not rotated:**

- Propeller bush is worn or damaged.
- Drive shaft is damaged.
- Propeller shaft is damaged.

**Engine speed will not increase:**

- Propeller is damaged.
- Propeller is not clean.
- Propeller is not properly selected.
- Outboard motor is not correctly installed.
- Trim angle is not properly adjusted.
- Spark plug is fouled or incorrectly selected.
- Fuel hose is kinked or pinched.
- Fuel filter is clogged.
- Fuel is deteriorated.
- Fuel pump is failed.
- Ignition system is failed.
- Electronic throttle system is failed.
- Heavy cargo is on the boat.
- Water has entered into the boat.
- Bottom of boat is not clean or damaged.

**Engine vibrates excessively:**

- Propeller is damaged.
- Engine mounting bolts or clamp screws are loose.

**The Keyless Start System does not turn ON even when the engine switch is operated. The error sound (three short buzzer beeps) is NOT heard:****(If equipped with Keyless Start System)**

- Emergency stop switch lock plate is not in position.
- Battery terminal connection is corroded or lost.
- Battery power is lost.
- Keyless control unit failure.
- Electric wiring connection is loose.
- Engine switch panel failure.

**The Keyless Start System does not turn ON even when the engine switch is operated. The error sound (three short buzzer beeps) IS heard:****(If equipped with Keyless Start System)**

- Keyless fob is outside the operating range.
- Keyless fob battery is dead.
- Keyless fob is in OFF mode.
- The keyless fob is not authenticated.
- Communication failure due to strong radio wave or noise.
- Electric wiring connection failure between the keyless control unit and outboard motor.
- Authentication error between the keyless control unit and outboard motor.
- Abnormality exists in the electronic control system of the engine.

**The Keyless Start System does not turn OFF even when the engine switch is operated:**

- Electric wiring connection is loose.
- Engine switch panel failure.



# FUSE

1. If equipped with Keyless Start System:  
Turn the Keyless Start System OFF.  
If not equipped with Keyless Start System:  
Turn the ignition key to the "off" position.
2. Remove the motor cover.
3. Remove the fuse box cover and pull off the fuse.

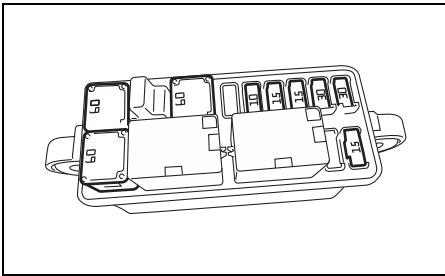
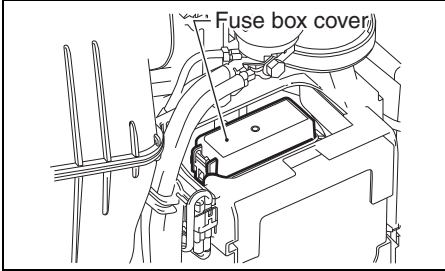

**NOTE:**  
Use the fuse puller at the back of fuse box cover, when the fuse is pulled off and installed.

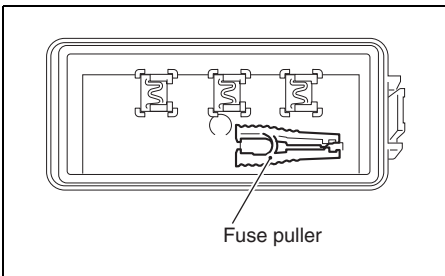

4. Remove the sub battery cable fuse.

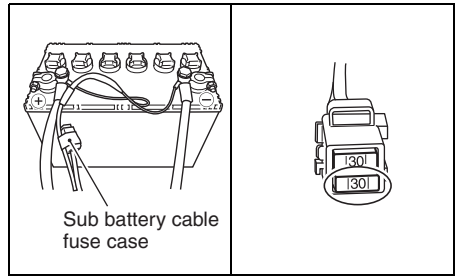

5. Inspect the fuse and replace with new fuse if needed.

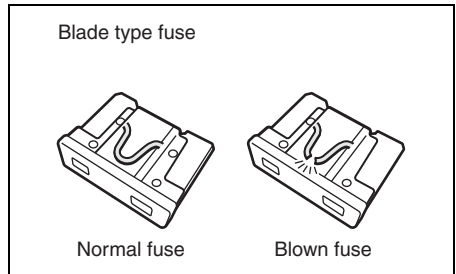
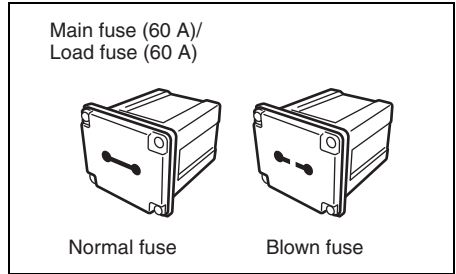

**NOTE:**  
If a fuse is blown, try to determine the root cause and correct it.  
If the cause is not corrected, the fuse may be blown again.

## **▲ WARNING**

If you replace a blown fuse with a fuse having a different amperage rating or with a substitute such as aluminum foil or a wire, extensive electrical system damage and a fire may result.

Always replace a blown fuse with a fuse of the same type and rating.

## NOTICE

If a new fuse blows in a short time after installation, you may have a major electrical system problem.

Consult your SUZUKI marine dealer.

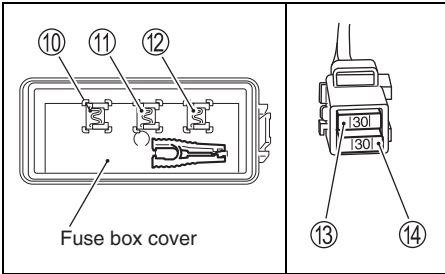
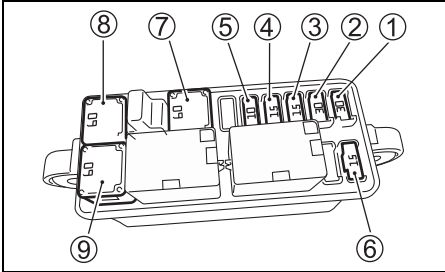

- ① Starter motor relay fuse: 30 A
- ② Ignition coil/Injector/Engine control module: 30 A
- ③ Throttle valve fuse: 15 A
- ④ Shift actuator fuse: 15 A
- ⑤ PTT switch fuse: 10 A
- ⑥ Fuel pump fuse: 15 A
- ⑦ Load fuse: 60 A
- ⑧ Main fuse: 60 A
- ⑨ Spare fuse: 60 A
- ⑩ Spare fuse: 30 A
- ⑪ Spare fuse: 15 A
- ⑫ Spare fuse: 10 A
- ⑬ Spare fuse: 30 A
- ⑭ Sub battery cable fuse: 30 A

### NOTE:

Spare fuses ⑩, ⑪ and ⑫ are provided for the back of fuse box cover.

# SPECIFICATIONS

Item	DF115BG	DF140BG
Engine Type	4 Stroke	
Number of Cylinders	4	
Bore and Stroke	86.0 × 88.0 mm (3.39 × 3.46 in)	
Piston Displacement	2045 cm <sup>3</sup> (124.8 cu. in)	
Maximum output	84.6 kW (115PS)	103.0 kW (140PS)
Full Throttle Operating Range	5000 – 6000 r/min. (min <sup>-1</sup> )	5700 – 6300 r/min. (min <sup>-1</sup> )
Ignition System	Full-transistor	
Engine Lubrication	Trochoid pump pressure lubrication	
Engine Oil Capacity	5.5 L (5.8/4.8 US/Imp. qt.)	
Gear Oil Capacity	1.05 L (1.11/0.92 US/Imp. qt.)	
Spark Plug	NGK LKR6E	
Spark Plug Gap	0.8 – 0.9 mm (0.031 – 0.039 in)	
Valve Clearance (Lash)	IN. : 0.23 – 0.27 mm (0.009 – 0.011 in) EX.: 0.33 – 0.37 mm (0.013 – 0.015 in)	
Fuel Type	Alcohol-free unleaded gasoline	
Minimum Fuel Octane Rating	91 (Research method)	

## INFORMATION REGARDING EC – DIRECTIVE

(For European countries)

### Sound Pressure Level

Regulation	Sound pressure level limit
2013 / 53 / EU	75 dB(A)

Sound pressure level is measured according to ISO 14509-1:2018.

# FLOWCHART OF OIL CHANGE REMINDER SYSTEM

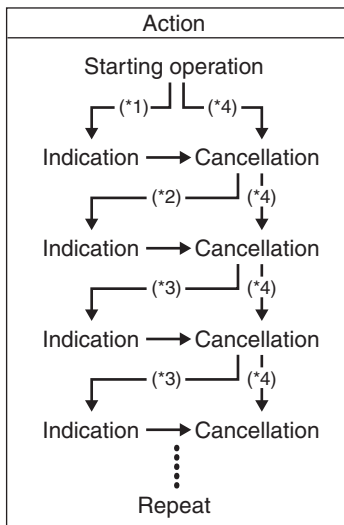

\*1: Lapse of initial 20 hour's operation

\*2: Lapse of 80 hour's operation

\*3: Lapse of 100 hour's operation

\*4: When performing cancellation before system activation

Prepared by

**SUZUKI MOTOR CORPORATION**

June, 2022

Printed in Japan

© COPYRIGHT SUZUKI MOTOR CORPORATION 2022