

GALA
INFLATABLE BOATS



CHELLENGER
Series

Inflatable canoes

C320

C380

C450

C520

User's Manual

CHALLENGER Series - inflatable canoe

C320, C380, C450, C520

User's Manual

CONTENTS	Page
Part 1. Specifications and assembling	2
1. Models specification	2
2. Standard features and optional equipment	2
3. Boat views	3
4. Boat assembling	4
5. Valves operation.....	5
Part 2. Safety and precautions	6
6. Recommendation signs	6
7. An important message	6
8. Certification.....	7
9 Identification	7
10. Manufacturer's ID plate	7
11. Motor type, installation and operating	9
12. Boat operating instructions:	11
a. Distribution of the load	
b. Checklist before departing	
c. Rules to observe during navigation	
d. Moring and towing	
e. Lifting	
f. Trailer	
13. In case of accident	14
14. Environment	14
15. Maintenance:	15
a. Cleaning	
b. Air tightness of inflatable tube	
c. Maintenance of stainless-steel	
d. Maintenance of the aluminium and plywood seats and floor	
e. Winterizing and storage	
f. Regular inspections	
16. Contacts and Service	16

Part 1. Specifications and assembling

1. MODELS AND SPECIFICATIONS

C320, C380, C450, C520 – inflatable canoes with high-pressure air deck

<i>Models</i>		C320	C380	C450	C520
Length overall	<i>cm</i>	320	380	450	520
	<i>ft/inches</i>	10' 6"	12' 6"	14' 9"	17' 1"
Length inside	<i>cm</i>	257	317	387	457
	<i>ft/inches</i>	8' 5"	10' 5"	12' 8"	15' 0"
Width overall	<i>cm</i>	104	104	104	104
	<i>ft/inches</i>	3' 5"	3' 5"	3' 5"	3' 5"
Width inside	<i>cm</i>	40	40	40	40
	<i>ft/inches</i>	1' 4"	1' 4"	1' 4"	1' 4"
Tube diameter	<i>cm</i>	32	32	32	32
	<i>ft/inches</i>	13"	13"	13"	13"
Boat weight	<i>kg</i>	20	24	29	34
	<i>lbs</i>	44	53	64	75
Loading capacity	<i>kg</i>	320	380	450	550
	<i>lbs</i>	704	836	990	1210
Passengers capacity		2	3	4	5
No of chambers		4+1	4+1	4+1	4+1
Engine recommended	<i>HP</i>	3	4	6	6
	<i>kW</i>	2,2	2,9	4,4	4,4
Engine power max	<i>HP</i>	4	6	8	8
	<i>kW</i>	2.9	4.4	5.9	5.9
Engine weight max	<i>kg</i>	25	35	40	40
	<i>lbs</i>	55	77	88	88
Engine shaft length	<i>inches</i>	15" (short)	15" (short)	15" (short)	15" (short)
Design category		D	D	D	D

All technical data are subject to change without notice. The products details and specifications may be changed from specified herein. All the dimensions are + or - 3%. All the weights are + or - 10%

2. STANDARD FEATURES AND OPTIONAL EQUIPMENT

STANDARD FEATURES:

- High-pressure inflatable air deck
- Integral laminated transom with one-way drain valve
- Aluminium seats with sliding system: C320 – 1pc, C380, C450 – 2pcs, C520 – 3 pcs.
- Substantial lifeline
- 4-chamber PVC buoyancy tube
- Rubbing strake with splash guard
- Two rear fins
- Two front water deflectors
- Bow part bottom protection
- Carry bag
- Foot pump, repair kit and manual

OPTIONAL EQUIPMENT:

- Soft cushion for aluminium seat
- Under-seat bag

3. BOAT VIEWS

Boat models :



C320
4HP, 2 pers



C380
6HP, 3 pers



C450
8HP, 4 pers



C520
8HP, 5 pers

General boat views :

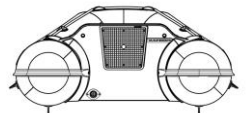
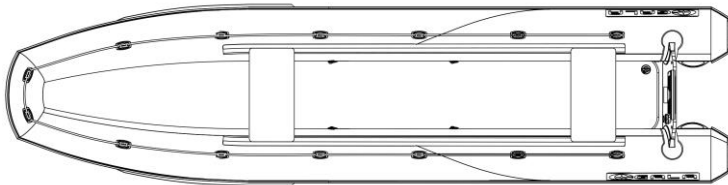
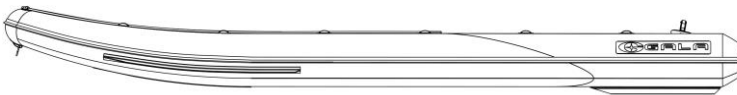

Rem: the present views are for model A300. Views for other models are similar.

4. BOAT ASSEMBLING

- Step 1:**
Open the boat
- Inspect the condition of the package for and report to your dealer if you find any damages.
 - Remove all the packaging plastic and cardboard carefully. Do not use knife.
 - Check the completeness of the boat and make sure that no any parts are missing. You must report the missing part to your dealer immediately.
- Step 2:**
Inflate the boat
- Open the pump, connect the pump hose to the pump onto inflation opening.
 - Connect bayonet adapter of the pump hose to the valve
 - **Inflate the rear compartments first** up to pressure slightly below nominal, **and the bow compartment the last** up to the nominal pressure. In this case the flexible baffles in the tube will move towards the rear compartments and equalize the pressure in all compartments. You may use the manometer to measure the pressure level to ensure the best performance of the boat and make sure that the pressure is about nominal level. Nominal tube pressure is mentioned on Capacity Plate.
 - switch the mode of your foot pump to high pressure mode and inflate the air deck up to nominal pressure (0.6 bar/ 9 psi)
- Step 3:**
Install the seats
- Unpack the seats and install them. For that slide the side seat railings into the seat slots on both sides. Always keep the seats at a distance not less than 100mm (4 inches) from the seat rail ends.
- Step 4:**
Install the motor
- Install the motor following your motor User's Manual instructions.

5. VALVES OPERATION

a. INFLATION-DEFLATION VALVE operation:

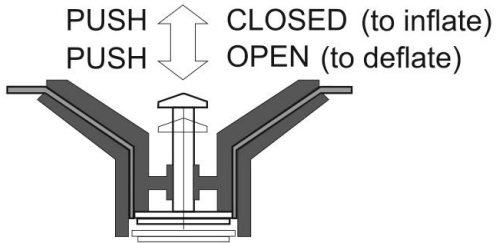

Inflation-deflation valve has PUSH-PUSH operating system: pressing the central pin the valve switches between OPEN and CLOSED. To inflate the tube put the pin to CLOSED position (pin moves UP). To deflate the tube put the pin to OPEN position (pin moves DOWN). After inflation every valve must be closed with the valve plug tight to ensure airtightness of the tube.

c. DRAIN VALVE operation:

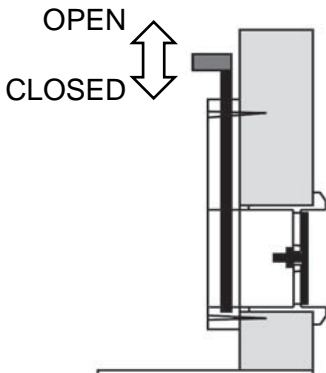

Drain valve includes

- Lifting OPEN-CLOSE lever: in upper position the valve is OPEN and water can get out of the cockpit, in lower position the valve is CLOSED and water passage is blocked
- one-way drain valve with petal prevent the water coming into the cockpit.





OVERINFLATING AND OVERHEATING OF YOUR BOAT MAY CAUSE THE BOAT DAMAGE. AVOID OVERPUMPING THE BOAT, LEAVING THE BOAT NOT COVERED, USING HIGH-PRESSURE INFLATORS. USE MANOMETER TO CHECK THE PRESSURE IN THE TUBE REGULARLY

Part 2. Safety and precautions

6. RECOMMENDATION SIGNS

Throughout this manual there are advisories of safe operation.
The symbols below are advisories relative to various types of situations

 DANGER	DENOTES AN EXTREME INTRINSIC HAZARD EXISTS WHICH WOULD RESULT IN HIGH PROBABILITY OF DEATH OR IRREPARABLE INJURY IF PROPER PRECAUTIONS ARE NOT TAKEN
---	--

 WARNING	DENOTES A HAZARD EXISTS WHICH CAN RESULT IN INJURY OR DEATH IF PROPER PRECAUTIONS ARE NOT TAKEN
--	---

 CAUTION	DENOTES A REMINDER OF SAFETY PRACTICES OR DIRECTS ATTENTION TO UNSAFETY PRACTICES WHICH COULD RESULT IN PERSONAL INJURY OR DAMAGE TO THE CRAFT OR COMPONENTS
NOTICE:	GIVES IMPORTANT INSTRUCTIONS

7. AN IMPORTANT MESSAGE

 CAUTION	<ol style="list-style-type: none">1. THIS USER'S MANUAL MUST BE ON YOUR BOAT, IN A SECURE AND EASILY ACCESSIBLE PLACE FOR PILOT.2. WE TAKE NO RESPONSIBILITY FOR THE CONSEQUENCES OF ACTIONS NOT COMPLYING WITH THE INSTRUCTIONS DESCRIBED IN THIS MANUAL.3. ALL THE INFORMATION HERE IS RIGHT FOR THE TIME OF ISSUE. WE RESERVE THE RIGHT TO CHANGE THE CHARACTERISTICS, DESIGN OR AVAILABILITY OF BOAT MODELS, PARTS AND ACCESSORIES ANY TIME.4. CONTACT YOUR LOCAL DEALER FOR LATEST UP-TO-DATE DETAILS, SPECIFICATIONS AND DOCUMENTS
--	---

8. CERTIFICATION

All our boats comply with ISO standard ISO6185, established by the International Standards Organization, and with the European Directive 2013/53/EU.

9. IDENTIFICATION

Every boat has “Craft Identification Number” (CIN), which uniquely identifies your boat and is important for safety purpose. The CIN is marked on non-removable metal plate, which is affixed onto the transom area of your boat:

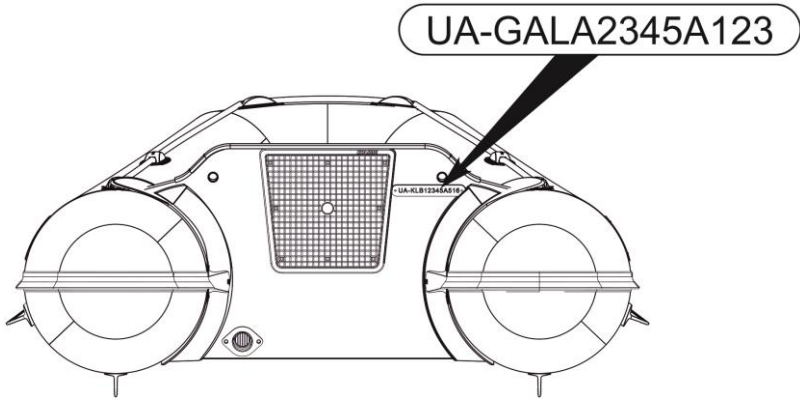

10. MANUFACTURER'S ID PLATE

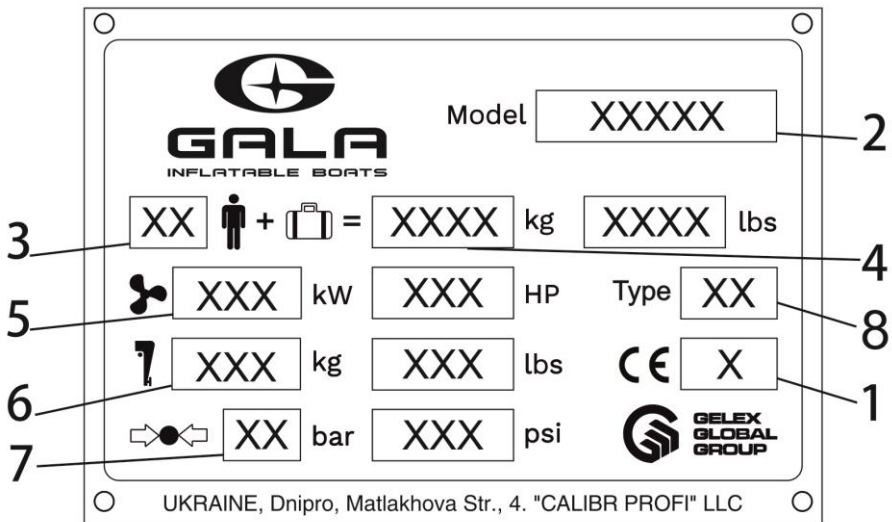

The indications on the capacity plate give information about limitations imposed by international regulations. Your local regulations can be different. Also these indications are not a complete list: the security requirements (obligatory security equipment of the boat, maximum authorized distance you can navigate from a shelter, etc.) may change according to the country or state.

Always refer to local regulations to be informed on actual requirements.

The details of the capacity plate are:

1 - Design category (European Directive 2013/53/EU):

Category	C	D
Navigation	"Near the shore"	"Protected water"
Wind speed (Beaufort scale)	Until 6 included	Until 4 included
Significant height of wave to consider (in meters)	Until 2 included	Until 0.5 included

 WARNING	<p>BE RESPONSIBLE, TAKE NOTICE OF THESE PARAMETERS WHEN YOU PLAN YOUR NAVIGATION PROGRAM, AND DO NOT PUT TO SEA IF THE CONDITIONS ARE LIKELY TO EXCEED THESE PARAMETERS</p>
---	---

2 - MODEL: Commercial name of the model.

3 - Maximum number of people authorized on board (adults + children) according to ISO and DIN standards.

4 - Maximum load capacity of the boat allowed by the manufacturer and expressed in kilograms and lbs.

5 - Maximum outboard power allowed by the manufacturer for the boat and expressed in kilowatts and lbs.

6 - Maximum outboard weight allowed by the manufacturer for the boat and expressed in kilograms and pounds.

7 - Nominal Pressure of the buoyancy tubes in Bars and Psi. Other parts of the boat can require different pressures Refer to the INFLATION chapter of the Owner's Manual Volume 2.

8 - Vessel type by ISO6185 classification.

11. MOTOR TYPE, INSTALLATION AND OPERATING

11.1. The maximum and recommended powers are listed in the table of technical specifications. For smaller outboards use the tiller control. For 25HP and up we strongly suggest to use the steering console with remote system.



NEVER USE MOTOR WITH POWER HIGHER THAN INDICATED, AND MOTOR WEIGHT HEAVIER THAN INDICATED ON THE MANUFACTURER'S ID PLATE. IT COULD RESULT IN LOSS OF CONTROL, AND YOU WOULD BE BREAKING THE LAW

11.2. MOTOR SHAFT LENGTH

The motor shaft length must be same as required for your boat (see boat specifications). Using motors with other shaft length may cause the boat damage and will void warranty.

11.3. PROPELLER

To choose the optimal propeller your boat and its motor must be tested at sea. A lower pitch is better for the boat either heavily loaded or used for water skiing. A higher pitch will increase the speed potential, when loaded light.

11.4. MOTOR INSTALLATION

Install the motor along the centerline of the boat in the middle on the mounting plate (1). Fully tighten the clamps (2) and tighten them again after 15 minutes of running. Secure the motor to the transom with safety cable. All motors are equipped with a security stop switch lanyard (3). Always use it!



THE BOLTING OF THE MOTOR TO THE TRANSOM IS SUGGESTED FROM 10HP AND HIGHLY RECOMMENDED FROM 25 HP AND ABOVE



CAUTION

1. FOR NOT BOLTED MOTORS TO THE TRANSOM: ALWAYS CHECK IF THE CLAMPS ARE PROPERLY TIGHTENED BEFORE DEPARTURE AND ON THE WAY.
2. FOR OUTBOARDS WITH REMOTE STEERING UNIT: CHECK IF ALL THE CONNECTIONS AND NUTS ARE IN GOOD ORDER AND TIGHTENED

11.5. MOTOR ADJUSTMENTS

The motor requires an adjustment of its position in trim and height for better performance in different navigation conditions and load distribution in the boat.

a) Motor height

For different makes of motors, even inside the same type of shaft, the length of the shaft can vary. It is necessary to add a shim to ensure correct height.

Correct motor height: it may vary from 0 to 30mm clearance between keel line and anti-cavitation plate of the motor. Check the motor manual for exact instructions.

Motor adjusted too high : propeller aeration may occur with loss of forward thrust (cavitation).

Motor adjusted too low : loss of speed and more difficult steering may occur (splashes).

b) Motor trim:

The motor must be positioned so that the axis of the propeller is parallel with the water surface. For better performance it can be adjusted either manually or with power trim, if the motor is equipped with it.

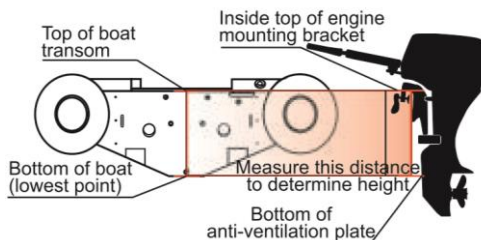

Optimum position: axis of the propeller is parallel with the water surface.



Motor tilted outwards too far from the transom: the boats will porpoise.



Motor tilted inwards too near the transom: the boat will bow down.



WARNING

1. MAKE ANY MODIFICATIONS OF THE MOTOR ONLY WHEN THE MOTOR IS SHUT OFF.
2. FOR ANY INFORMATION ABOUT MOTOR ITSELF REFER TO THE MOTOR'S MANUAL

a) Distribution of the load

Evenly distribute the load. (For example, fixing the fuel tank on the front can help to offset the weight of the outboard).

 CAUTION	<ol style="list-style-type: none"> 1. A BAD DISTRIBUTION OF THE LOAD CAN DESTABILIZE THE BOAT AND MAY RESULT IN A LOSS OF CONTROL. 2. THE BOAT REACTS MORE ROUGH WHEN LIGHTLY LOADED. 3. BE PARTICULARLY CAREFUL WHEN YOU ACCELERATE OR CHANGE DIRECTION. 4. ADJUST LOAD DISTRIBUTION AND TRIM WHEN NAVIGATION CONDITIONS OR WAVES DIRECTION CHANGE.
---	--

b) Check-list before departure:

 WARNING	<p>GET REQUIRED INFORMATION AND INFORM OTHER PASSENGERS:</p> <ol style="list-style-type: none"> 1. GET INFORMED on local regulations and hazards related to water activities and boat operation. 2. CHECK weather forecast, local currents, tides and wind conditions. 3. ADVISE someone on land of time you plan to be back. 4. EXPLAIN basic boat operation to all passengers. 5. BE SURE that one of your passengers can operate the boat in case of emergency. 6. LEARN how to determine the distance you can cover with a full fuel tank. Always be sure you have enough fuel to reach a shelter. <p>CHECK THE GOOD WORKING OF THE BOAT AND EQUIPMENT:</p> <ol style="list-style-type: none"> 1. CHECK inflation pressure. 2. INSPECT the valve caps. Remove the bailer plug. 3. CHECK the tightening of the motor clamps. For not bolted, secure the engine with a safety lanyard. 4. TOP OFF fuel and oil level. 5. CHECK the secure and correct installation of fuel tank. 6. BE SURE motor is not in gear before starting. 7. CHECK the load is evenly distributed. 8. CHECK that required safety equipment is on board: <ol style="list-style-type: none"> a. One personal flotation device per person; b. The foot-pump, paddles or oars, repair kit; c. The boat papers and your boating license; d. Lights are required if operating in dark.
---	---

c) Rules to observe during navigation:

- Be responsible: do not neglect the safety rules.
- Learn to always keep control of your boat.
- Always operate with courtesy and respect.
- Respect local regulations and practices.
- Near the shore, navigate in the designated boating areas.
- Always be sure that you can reach a shelter rapidly.



1. WEAR PERSONAL FLOTATION DEVICE (PFD)
2. ALWAYS USE THE STOP SWITCH LANYARD: wear it around your wrist or affix to your clothes.
3. NO ALCOHOL / DRUGS BEFORE OR WHILE OPERATING YOUR BOAT.
4. DO NOT EXCEED THE AUTHORIZED NUMBER OF PERSONS OR WEIGHT.
5. MAKE SURE YOUR PASSENGERS REMAIN SEATED ON SEATS OR ON THE FLOOR. AVOID SEATING ON TUBES.
6. NO BOW RIDING AS IT IS ILLEGAL AND EXTREMELY DANGEROUS.
7. BE ESPECIALLY CAREFUL WHEN DOCKING: Arms and legs may be injured if they are outside the boat.
8. KEEP CLEAR OF SWIMMERS AND DIVERS: Always avoid areas where divers/swimmers are in the water. Keep a sharp lookout especially when operating near beaches and launch sites. Shut off the motor when operating near someone in the water. The Alpha flag indicates proximity of divers. You MUST stay at a good distance (minimum 50 meters).
9. AVOID SHARP TURNS AT HIGH SPEEDS: You could get ejected from the boat.
10. DO NOT make a brutal change in direction without advising passengers.
11. NO SPEEDING OR RACING! Driver must keep reasonable speed to avoid any boat stability loss.
12. BATTERY:
 - a. Avoid sparks and open flames near battery. It may explode.
 - b. Keep battery poles protected from any shortcut or contact with any metal things.
 - c. Turn off the engine when inspecting or servicing the battery.
 - d. Never keep battery close to fuel tank, filler or fuel system elements.
13. AVOID any contact of the inflatable tube with any sharp objects or aggressive liquids or chemicals.
14. INSPECT AND MAINTAIN STEERING SYSTEM: an improperly maintained system may fail, causing sudden loss of control.



15. AVOID THE RISKS OF EXPLOSION OR FIRE
HAZARDS : Ensure your fuel system is in a good with no leaks or smell, and maintain it properly.
16. AVOID SMOKING ON BOARD.
17. IF FUEL HAS SPILLED ON THE FLOOR: wash off with water. Stop operating the boat if you discover any fuel leak or fuel smell until you find and fix the problem.

d) Mooring and towing:

- MOORING: use the buoyancy tubes' lateral D-rings. When moored, the self-bailers should remain open to drain the rain water.
- TOWING: fully inflatable boats should always be towed using a bridle. Use the 2 lateral D-rings (fixed on the buoyancy tubes) made for this purpose. For rigid inflatable boats (RIB), use a single line attached to the mooring ring.



1. Towing must be done at low speed (not more than 10 km/h) and in good weather conditions with no waves.
2. Towing boat must be supervised at all time of towing.

e) Lifting the boat:

To lift boat and place it on davits, use the factory installed lifting eyes only, or have them installed by your Dealer if the boat is not equipped. Use only certified and rated lifting slings, appropriate for your boat and motor weight.



1. NOBODY ON BOARD WHEN LIFTING.
2. WHEN LIFTED, THE BOAT MUST BE EMPTY (NO EQUIPMENT) AND TIPPED TOWARD THE REAR WITH OPEN BAILERS.

f) Trailer and davits system use:

- The trailers size and carrying capacity should correspond to your boat size and weight. Do not use too big or too small trailer for your boat.
- Always prefer trailer / davits system with bolsters / banks with large contact spot to rollers. Do not use the trailers / davits system with rollers only.
- The boat must be properly inflated. Leave the self-bailer open.
- Haul the boat onto the trailer using the bow eye.
- Lift the engine shaft down and fix it to the support provided on a trailer. Do not trailer or store the boat on davits without proper engine support on the trailer.
- Tie down the boat with straps, using bow, lateral and rear eyes for that.
- Close and secure all hatches and doors on the boat. Cushions must be secured or taken away to prevent the loss.
- Do not trailer the boat with the cover, which is not designed for transportation.

13. IN CASE OF ACCIDENT

In case of accident:

- Do not panic and reassure passengers.
- Be aware that your boat, even damaged, is often the best shelter and facilitates your rescue. Never leave the boat it floats, as the inflatable boat is practically unsinkable, even full of water.
- If, after an accident, a compartment deflates, bring it inside the boat, restore the load balance to the opposite side of the deflated compartment and return at reduced speed.
- In case of a collision or an impact with a floating object, stop to examine the hull, the buoyancy tubes, the motor and its attachments and return to shore at a low speed.
- Take your boat to your Dealer for inspection before using it again.



NEGLECTING INSPECTIONS AND REPAIRS MAY
LEAD TO A SERIOUS INJURY, BOAT DAMAGE
AND WILL REDUCE THE LIFE OF YOUR BOAT

14. ENVIRONMENT

RESPONSIBLE BOATING BEGINS WITH YOU!

Respect your environment by applying the following basic safety rules:

- AVOID CREATING EXCESSIVE WASH.
- KEEP OUT OF DESIGNATED SWIMMING AREAS.
- RESPECT ALL ANIMAL LIFE.
- BE CAREFUL NOT TO OVERFILL THE FUEL TANK.
- DON'T MAKE UNNECESSARY NOISE.
- DO NOT DISCHARGE OIL OR FUELS INTO THE WATER.
- DO NOT LITTER.
- DONT MAKE EXCESSIVE WAKE.

The health of your environment depends on us all acting responsibly to ensure a clean tomorrow. If each of us follows these few simple rules, we can help to keep the Earth's resources intact for future generations.

a) Cleaning:

- Clean your boat often, and obligatory before winterizing.
- For cleaning use SOAP AND FRESH WATER ONLY!
- At all times keep the inflatable tube, vinyl and other boat parts free of any chemical ingredients like:
 - Gasoline, grease, oil and any other oily product;
 - Suntan oils, lotions and any other body care products;
 - Pollution ingredients, dirt and dust;
 - Silicon based products, automotive chemical products.
- Clean and rinse the boat or its part as soon as possible once you find these ingredients on your boat to prevent the damage.
- Keep your boat properly covered all the time you do not use it.
- Keep your boat away of or well protected against car or other exhaust smoke or pollution, which may damage the boat.



1. NEVER USE ANY OTHER THAN SPECIFIED CHEMICALS, CLEANING LIQUIDS OR AGENTS, TO AVOID DAMAGE OF YOUR BOAT.
2. NEVER USE HIGH PRESSURE CLEANING EQUIPMENT TO AVOID DAMAGE OF THE BOAT.

b) Air tightness of inflatable tube:

- As the inflatable tube is a main safety feature - check airtightness of your boat regularly. Inspect the condition of all inflatable compartments with soap foam, and make sure that:
 - there is no material cracks, holes and leaks;
 - all inflation valves and seams are intact.
- ISO 6185 standard permits a certain amount of pressure loss - 30%: 45 mbar (0.63 psi) per 24 hours for the buoyancy tube, what is stated as acceptable. This requirement is applicable only for main flotation volumes – inflatable tube, and not to inflatable seats, keels, floors and other inflatable parts.
- Once you discover the pressure decrease – just add some air by foot pump. Never use high-pressure inflators to inflate the boat.
- Temperature has a great influence on air pressure. A variation of 1°C results in a variation in the same way of about +/- 4 mb (0,06 psi).
- If you discover sufficient pressure drop, but do not see actual leakage:
 - Step 1: check the inflation/deflation valves and overpressure valves (if there is one);
 - Step 2: check the major seams;
 - Step 3: check the tube material from the top to the bottom. Contact your Dealer for advice if necessary.
- Every discovered source of leakage must be properly repaired. Do not operate leaking boat.

c) Maintenance of stainless steel:

- We use only top quality stainless steels, which are resistant to corrosion. However, it is not permanent and maintenance is required:
 - Avoid contamination and scoring its surface,
 - Frequently wash with fresh water,
 - Grease and mirror polish it regularly.
- Once you see the sign of rust – clean and mirror polish this place.

d) Maintenance of the aluminium and marine ply elements and floor:

- Wash the seats and floor with soap and fresh water, and dry thoroughly. Paints and varnishes not only are decorative elements, they also protect the material.
- Repaint flakes or scratches on the surface with proper paint.
- If you see any sign of corrosion or scratches – clean it, remove any corrosion signs and protect the area with proper paint.

e) Winterizing and storage

- When storing your boat, keep it in a clean and dry place that is not affected from major variations in temperature and other factors.
- You may store the boat:
 - Deflated and rolled up in its bag.
 - Assembled and slightly inflated, covered with the cover, which protects against direct sunlight, dirt, dust and pollution.
- For winterizing:
 - Clean and dry the boat, all foam and wooden elements,
 - Completely drain the water out of the hull.
 - Grease all metal moving parts and connections, incl. steering.
 - Properly close the fuel system to avoid any vapor leak.
 - Keep the boat breathable. Use breathable canvas.
 - Winterize the motor, following the instructions for the motor.



1. DO NOT STORE THE BOAT NOT COVERED.
2. STORE THE BOAT AWAY FROM RODENTS.
3. AVOID SHARP FOLDS OF TUBE MATERIAL.

f) Regular inspections:

- Check frequently the tightness of the screws and nuts, particularly the motor's bolting to the transom and steering system elements.
- Regularly examine your fuel system, replace old damaged elements and check the tightness of the clamping rings.

16. CONTACTS AND SERVICE

Our service network assures you a dependable service. With any questions related to boat design and use, maintenance and repairs, parts and materials supply please contact your local GALA Dealer or Importer.

You may find the list of them at our international web-site: www.gelexglobal.com

visit us at:
www.gala.boats

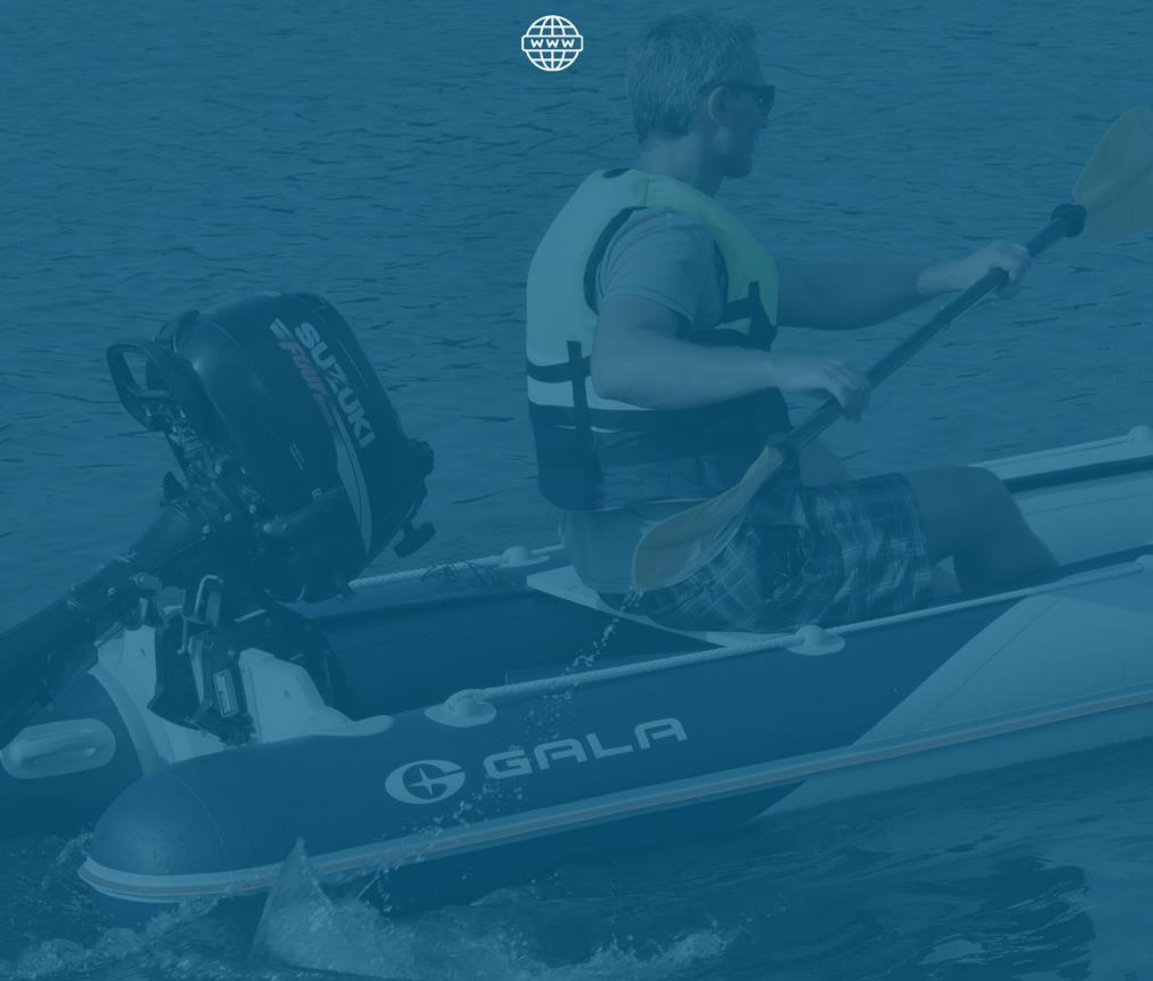

**GELEX
GLOBAL
GROUP**



**MADE IN
UKRAINE**